

AW-CM467-USB

IEEE 802.11 a/b/g/n/ac and Bluetooth 5.0 Module

Datasheet

Rev. C

DF

(For Standard)

Features

Wi-Fi

- Dual band 802.11 a/b/g/n/ac
- Single-stream spatial multiplexing up to 433.3 Mbps
- Supports 20, 40, and 80 MHz channels with optional SGI (256 QAM modulation).
- Security: WEP, WPA/WPA2 (personal), AES (HW), TKIP (HW), CKIP (software support)

Bluetooth

- Qualified for Bluetooth Core Specification 5.0 with all Bluetooth 4.2 optional features
- Supports extended synchronous connections (eSCO), for enhanced voice quality by allowing for retransmission of dropped packets.
- Adaptive Frequency Hopping (AFH) for reducing radio frequency interference
- Supports multiple simultaneous Advanced Audio Distribution Profiles (A2DP) for stereo sound.

Table of Contents

Features	2
Revision History	3
Table of Contents	4
1. Introduction	5
1.1 Product Overview	5
1.2 Block Diagram	6
1.3 Specifications Table	7
1.3.1 General	7
1.3.2 WLAN	7
1.3.3 Bluetooth.....	9
1.3.4 Operating Conditions.....	10
2. Pin Definition	11
2.1 Pin Map	11
2.2 Pin Table	12
3. Electrical Characteristics	15
3.1 Absolute Maximum Ratings	15
3.2 Recommended Operating Conditions	15
3.3 Digital IO Pin DC Characteristics	16
3.4 Host Interface	17
3.4.1 WLAN/BT USB Timing	17
3.5 Power up Timing Sequence	17
3.6 Power Consumption*	20
3.6.1 WLAN	20
3.6.2 Bluetooth.....	21
4. Mechanical Information	22
4.1 Mechanical Drawing	22
5. Packaging Information	23

1. Introduction

1.1 Product Overview

The Cypress AW-CM467-USB device provides the highest level of integration for embedded and IoT wireless systems with integrated single-stream IEEE 802.11a/b/g/n/ac, MAC/baseband/radio and Bluetooth 5.0 (Basic Rate, Enhanced Data Rate and Bluetooth Low Energy).

AW-CM467-USB supports all rates specified in the IEEE 802.11 a/b/g/n/ac specifications. IEEE 802.11ac's 256-QAM is supported for MCS8 in 20 MHz channels and MCS8/MCS9 in 40 MHz & 80 MHz channels to enable data rates of up to 433.3 Mbps. Included on-chip are 2.4 GHz and 5 GHz power amplifiers and low-noise amplifiers.

The WLAN section supports the following host interface USB 2.0 interface. The Bluetooth section supports USB 2.0, USB 1.1. An on-chip USB 2.0 hub provides a shared single USB connection to both WLAN and Bluetooth target devices.

Using advanced design techniques and process technology to reduce active and idle power, the AW-CM467-USB is designed to address the need of mobile devices that require minimal power consumption and compact size. It includes a power management unit (PMU) which simplifies the system power topology and allows for direct operation from a mobile platform battery while maximizing battery life.

The AW-CM467-USB implements highly sophisticated enhanced collaborative coexistence hardware mechanisms and algorithms, which ensure that WLAN and Bluetooth collaboration is optimized for maximum performance. As a result, enhanced overall quality for simultaneous voice, video, and data transmission on an embedded and IoT system is achieved.

1.2 Block Diagram

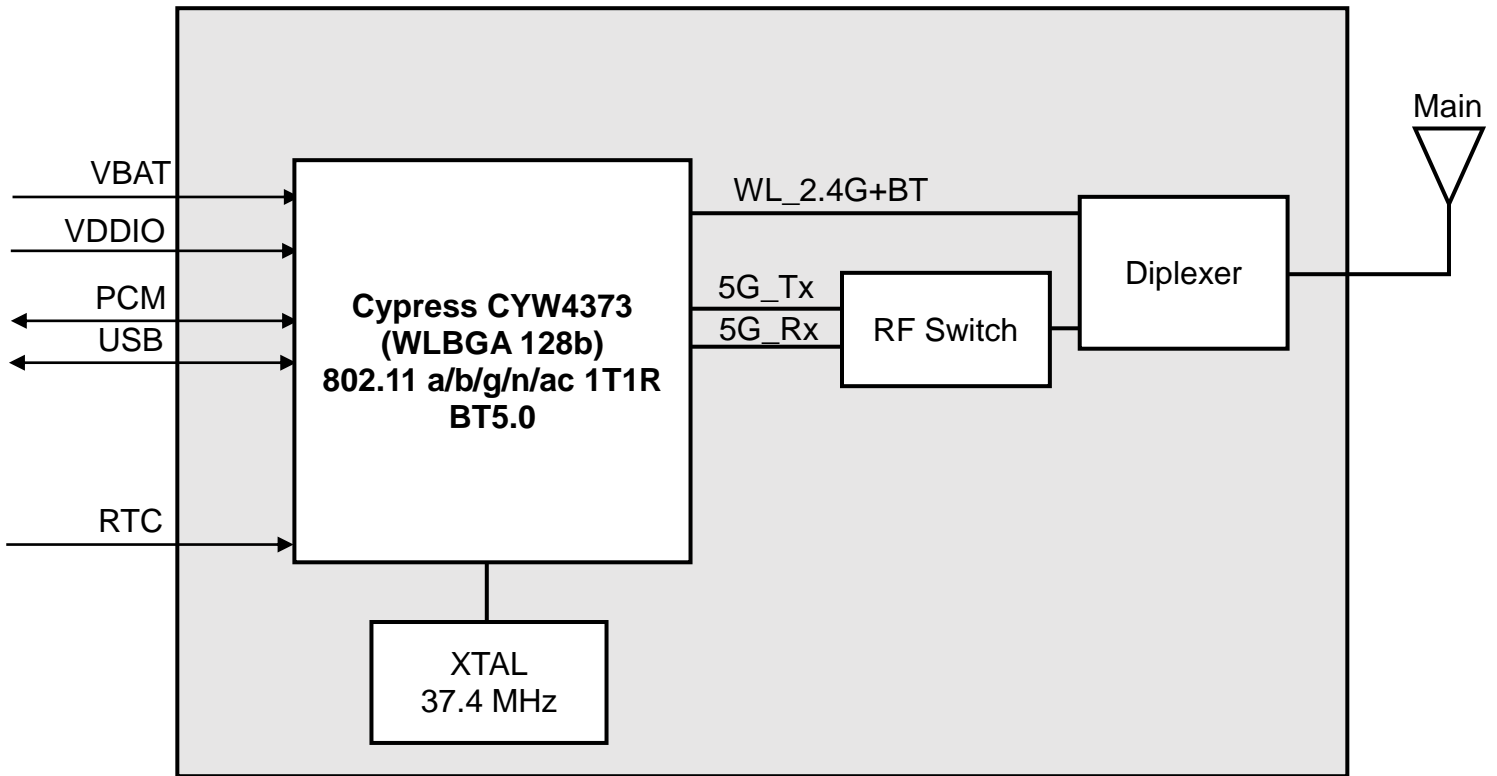

AW-CM467-USB BLOCK DIAGRAM

1.3 Specifications Table

1.3.1 General

Features	Description
Product Description	IEEE 802.11 a/b/g/n/ac Wireless LAN and Bluetooth Module
Major Chipset	Cypress CYW4373
Host Interface	WiFi + BT ● USB + USB
Dimension	12mm(L) x 12mm(W) x 1.65mm(T)
Form Factor	LGA module, 47 pins
Antenna	1T1R ANT1(Main) : WiFi/Bluetooth → TX/RX
Weight	0.2g

1.3.2 WLAN

Features	Description
WLAN Standard	IEEE 802.11a/b/g/n/ac 1T1R
WLAN VID/PID	N/A
WLAN SVID/SPID	N/A
Frequency Range	WLAN: 2.4 GHz / 5GHz Band
Modulation	DSSS DBPSK(1Mbps), DQPSK(2Mbps), CCK(11/5.5Mbps) OFDM BPSK(9/6Mbps/MCS0), QPSK(18/12Mbps/MCS1~2), 16-QAM(36/24Mbps/MCS3~4), 64-QAM(72.2/54/48Mbps/MCS5~7), 256-QAM(MCS8~9)
Number of Channels	802.11b: USA, Canada and Taiwan – 1 ~ 11 Most European Countries – 1 ~ 13 Japan – 1 ~ 13 802.11g: USA and Canada – 1 ~ 11

	Most European Countries – 1 ~ 13 802.11n: USA and Canada – 1 ~ 11 Most European Countries – 1 ~ 13 802.11a: USA – 36, 40, 44, 48, 52, 56, 60, 64, 100, 104, 108, 112, 116, 120, 124, 128, 132, 136, 140, 149, 153, 157, 161, 165				
Output Power¹	2.4G				
		Min	Typ	Max	Unit
	11b (11Mbps) @EVM<35%	15	17	19	dBm
	11g (54Mbps) @EVM ≤ -25 dB	13	15	17	dBm
	11n (HT20 MCS7) @EVM ≤ -27 dB	13	15	17	dBm
	11n (HT40 MCS7) @EVM ≤ -27 dB	11	13	15	dBm
	5G				
		Min	Typ	Max	Unit
	11a (54Mbps) @EVM ≤ -25 dB	13	15	17	dBm
	11n (HT20 MCS7) @EVM ≤ -27 dB	12	14	16	dBm
	11n (HT40 MCS7) @EVM ≤ -27 dB	10	12	14	dBm
	11ac (VHT20 MCS8) @EVM ≤ -30 dB	9	11	13	dBm
	11ac (VHT40 MCS9) @EVM ≤ -32 dB	7	9	11	dBm
	11ac (VHT80 MCS9) @EVM ≤ -32 dB	6	8	10	dBm
	Receiver Sensitivity¹	2.4G			
		Min	Typ	Max	Unit
11b (11Mbps)			-87	-84	dBm
11g (54Mbps)			-73	-70	dBm
11n (HT20 MCS7)			-73	-70	dBm
11n (HT40 MCS7)			-71	-68	dBm
5G(n/ac packets with LDPC)					
		Min	Typ	Max	Unit
11a (54Mbps)			-72	-69	dBm
11n (HT20 MCS7)			-70	-67	dBm
11n (HT40 MCS7)		-68	-65	dBm	

	11ac (VHT20 MCS8)		-67	-64	dBm
	11ac (VHT40 MCS9)		-62	-59	dBm
	11ac (VHT80 MCS9)		-59	-56	dBm
Data Rate	802.11b: 1, 2, 5.5, 11Mbps 802.11g: 6, 9, 12, 18, 24, 36, 48, 54Mbps 802.11n: MCS0~7 HT20/HT40 802.11a: 6, 9, 12, 18, 24, 36, 48, 54Mbps 802.11ac: MCS0~8 VHT20 802.11ac: MCS0~9 VHT40/VHT80				
Security	<ul style="list-style-type: none"> ● WPA™- and WPA2™- (Personal) support for powerful encryption and authentication ● AES and TKIP acceleration hardware for faster data encryption and 802.11i compatibility ● Wi-Fi Protected Setup (WPS) ● WEP ● CKIP(Software) ● WPA3 				

* If you have any certification questions about output power please contact FAE directly.

1.3.3 Bluetooth

Features	Description				
Bluetooth Standard	Bluetooth 2.1+Enhanced Data Rate (EDR)/BT3.0/BT4.2/BT5.0				
Bluetooth VID/PID	N/A				
Frequency Range	2400~2483.5MHz				
Modulation	GFSK (1Mbps), π/4DQPSK (2Mbps) and 8DPSK (3Mbps)				
Output Power¹		Min	Typ	Max	Unit
	Basic rate	6	8	10	dBm
	LE	6	8	10	dBm
Receiver Sensitivity¹		Min	Typ	Max	Unit
	DH5		-84	-81	dBm
	2DH5		-84	-81	dBm
	3DH5		-76	-73	dBm
	LE		-86	-83	dBm

¹ Note: this product is under development, and the RF performance is still being fine-tuned, so the relevant values may be subject to change without any notice

1.3.4 Operating Conditions

Features	Description
Operating Conditions	
Voltage	3.2 V– 4.8 V
Operating Temperature	-20°C ~70°C
Operating Humidity	less than 85% R.H.
Storage Temperature	-40°C ~85°C
Storage Humidity	less than 60% R.H.
ESD Protection	
Human Body Model	±2KV per MIL-STD-883H Method 3015.8
Charged Device Model	±250V per JEDEC EIA/JESD22-C101E

2. Pin Definition

2.1 Pin Map

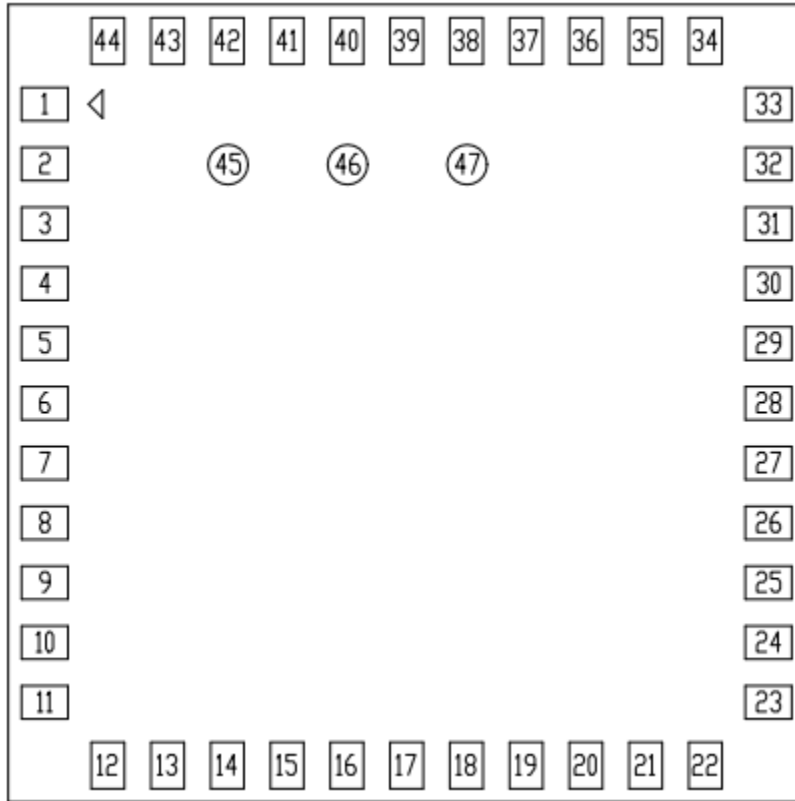

AW-CM467-USB Top View Pin Map

2.2 Pin Table

Pin No	Definition	Basic Description	Voltage	Type
1	GND	Ground.		GND
2	WL_BT_ANT	WLAN/BT RF TX/RX path.		RF
3	GND	Ground.		GND
4	NC	Floating Pin, No connect to anything.		Floating
5	NC	Floating Pin, No connect to anything.		Floating
6	BT_DEV_WAKE	Bluetooth DEV_WAKE.	VDDIO	I/O
7	BT_HOST_WAKE	Bluetooth HOST_WAKE.	VDDIO	I/O
8	NC	Floating Pin, No connect to anything		Floating
9	VBAT	3.3V power pin	3.3V	VCC
10	NC	Floating Pin, No connect to anything.		Floating
11	NC	Floating Pin, No connect to anything.		Floating
12	WL_REG_ON	Used by PMU to power-up or power down the internal CYW4373 regulators used by the WLAN section. Also, when deasserted, this pin holds the WLAN section in reset. This pin has an internal 200 kΩ pull-down resistor that is enabled by default. It can be disabled through programming.	VDDIO	I
13	WL_HOST_WAKE	WL Host Wake.	VDDIO	O
14	NC	Floating Pin, No connect to anything.		Floating
15	NC	Floating Pin, No connect to anything.		Floating
16	NC	Floating Pin, No connect to anything.		Floating
17	NC	Floating Pin, No connect to anything.		Floating
18	NC	Floating Pin, No connect to anything.		Floating
19	NC	Floating Pin, No connect to anything.		Floating
20	GND	Ground.		GND
21	VIN_LDO_OUT	Internal Buck 1.2V voltage generation pin.	1.4V	O

22	VDDIO	1.8V-3.3V VDDIO supply for WLAN and BT.	VDDIO	VCC
23	VIN_LDO	Internal Buck 1.2V voltage generation pin.	1.4V	I
24	LPO	External 32K or RTC clock.	0.2~3.3V	I
25	BT_PCM_OUT	PCM data output.	VDDIO	O
26	BT_PCM_CLK	PCM clock; can be master (output) or slave (input).	VDDIO	I/O
27	BT_PCM_IN	PCM data input.	VDDIO	I
28	BT_PCM_SYNC	PCM sync; can be master (output) or slave (input), or SLIMbus data.	VDDIO	I/O
29	NC	Floating Pin, No connect to anything.		Floating
30	NC	Floating Pin, No connect to anything.		Floating
31	GND	Ground.		GND
32	NC	Floating Pin, No connect to anything.		Floating
33	GND	Ground.		GND
34	BT_REG_ON	Used by PMU to power-up or power down the internal CYW4373 regulators used by the Bluetooth section. Also, when deasserted, this pin holds the Bluetooth section in reset. This pin has an internal 200 kΩ pull-down resistor that is enabled by default. It can be disabled through programming.	VDDIO	I
35	NC	Floating Pin, No connect to anything.		Floating
36	GND	Ground.		GND
37	USB_DM	Data minus of shared USB2.0 port.	3.3V	I/O
38	USB_DP	Data plus of shared USB2.0 port.	3.3V	I/O
39	RF_SW_CTRL5	Programmable RF switch control lines	3.3V	O
40	NC	Floating Pin, No connect to anything.		Floating
41	NC	Floating Pin, No connect to anything.		Floating
42	NC	Floating Pin, No connect to anything.		Floating
43	NC	Floating Pin, No connect to anything.		Floating
44	NC	Floating Pin, No connect to anything.		Floating

45	NC	Floating Pin, No connect to anything.		Floating
46	NC	Floating Pin, No connect to anything.		Floating
47	NC	Floating Pin, No connect to anything.		Floating

3. Electrical Characteristics

3.1 Absolute Maximum Ratings

Symbol	Parameter	Minimum	Typical	Maximum	Unit
VBAT	DC supply for the VBAT and PA driver supply	-0.5	-	5.5	V
VDDIO	DC supply voltage for digital I/O	-0.5	-	3.9	V
Tj	Maximum junction temperature	-	-	125	°C

3.2 Recommended Operating Conditions

Symbol	Parameter	Minimum	Typical	Maximum	Unit
VBAT	Power supply for Internal Regulator	3.2	3.6	4.8	V
VDDIO	DC supply voltage for digital I/O	1.62	1.8/3.3	3.63	V

3.3 Digital IO Pin DC Characteristics

Symbol	Parameter	Minimum	Typical	Maximum	Unit
Digital I/O pins, VDDIO=1.8V					
V _{IH}	Input high voltage	0.65 × VDDIO	-	-	V
V _{IL}	Input low voltage	-	-	0.35 × VDDIO	V
V _{OH}	Output high voltage	VDDIO – 0.45	-	-	V
V _{OL}	Output Low Voltage	-	-	0.45	V
Digital I/O pins, VDDIO=3.3V					
V _{IH}	Input high voltage	2.00	-	-	V
V _{IL}	Input low voltage	-	-	0.80	V
V _{OH}	Output high voltage	VDDIO – 0.4	-	-	V
V _{OL}	Output low Voltage	-	-	0.40	V

3.4 Host Interface

3.4.1 WLAN/BT USB Timing

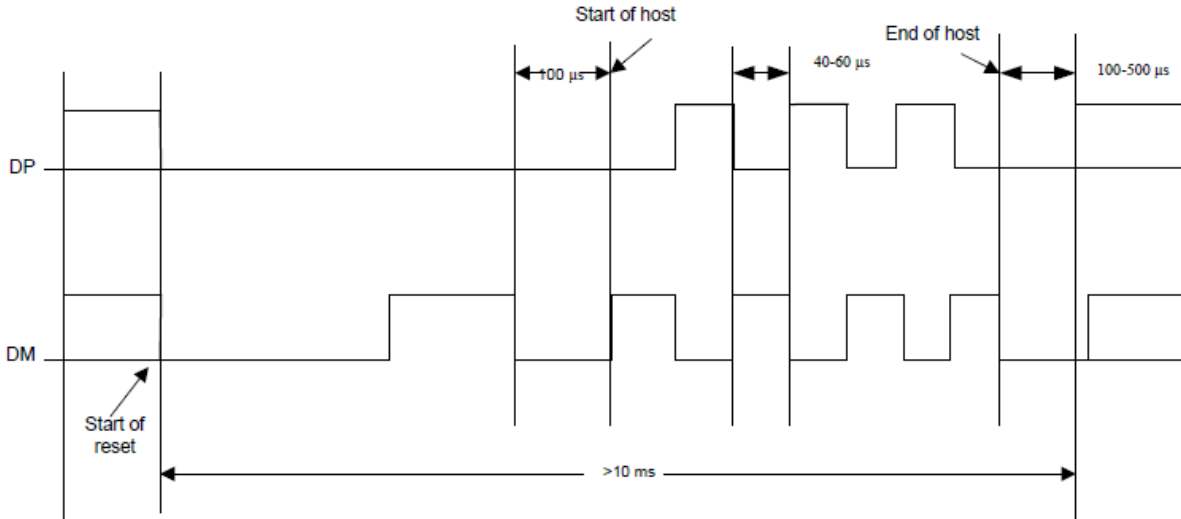

Note: The AW-CM467-USB has a USB2.0-PHY and HS HUB which can enable shared USB2.0 interface between WLAN and BT.

3.5 Power up Timing Sequence

The AW-CM467-USB has three signals that allow the host to control power consumption by enabling or disabling the Bluetooth, WLAN, and internal regulator blocks. These signals are described below. Additionally, diagrams are provided to indicate proper sequencing of the signals for various operational states. The timing values indicated are minimum required values; longer delays are also acceptable.

Description of Control Signals

■ WL_REG_ON:

Used by the PMU to power up the WLAN section. It is also OR-gated with the BT_REG_ON input to control the internal AW-CM467-USB regulators. When this pin is high, the regulators are enabled and the WLAN section is out of reset. When this pin is low the WLAN section is in reset. If both the BT_REG_ON and WL_REG_ON pins are low, the regulators are disabled.

■ BT_REG_ON:

Used by the PMU (OR-gated with WL_REG_ON) to power up the internal AW-CM467-USB regulators. If both the BT_REG_ON and WL_REG_ON pins are low, the regulators are disabled. When this pin is low and WL_REG_ON is high, the BT section is in reset.

Note:

For both the WL_REG_ON and BT_REG_ON pins, there should be at least a 10 msec time delay between consecutive toggles (where both signals have been driven low). This is to allow time for the CBUCK regulator to discharge. If this delay is not followed, then there may be a VDDIO in-rush current on the order of 36 mA during the next PMU cold start.

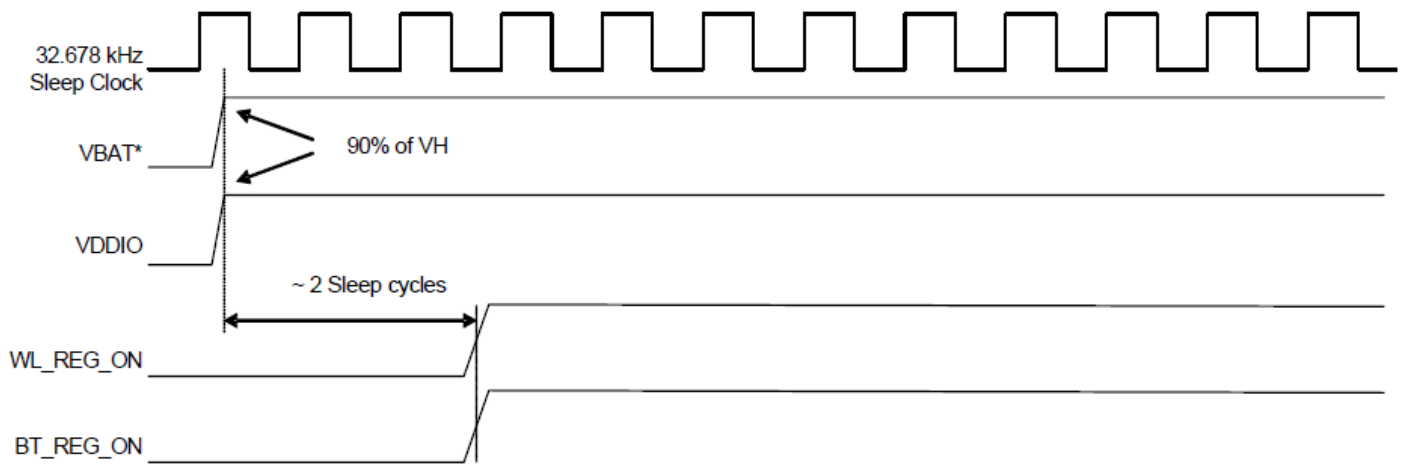

***Notes:**

1. VBAT should not rise 10%–90% faster than 40 microseconds.
2. VBAT should be up before or at the same time as VDDIO. VDDIO should NOT be present first or be held high before VBAT is high.

WLAN = ON, Bluetooth = ON

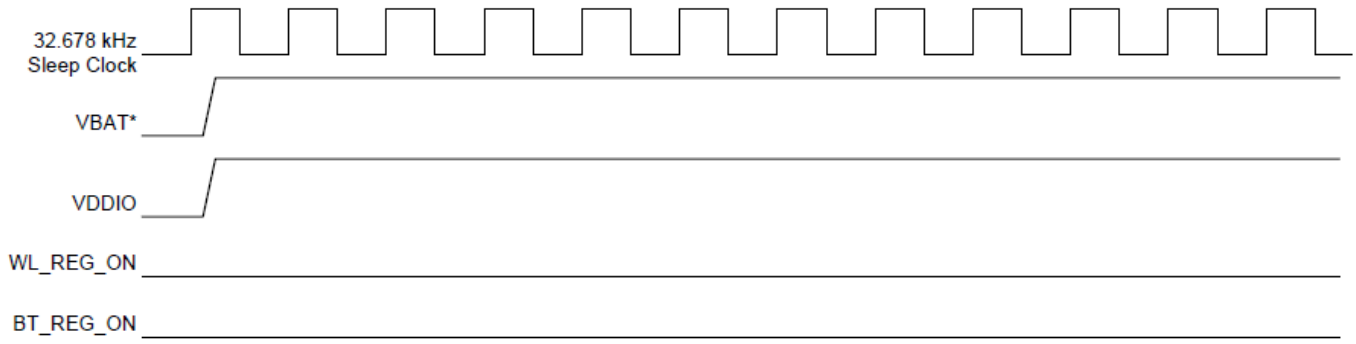

- *Notes:**
1. VBAT should not rise 10%–90% faster than 40 microseconds.
 2. VBAT should be up before or at the same time as VDDIO. VDDIO should NOT be present first or be held high before VBAT is high.

WLAN = OFF, Bluetooth = OFF

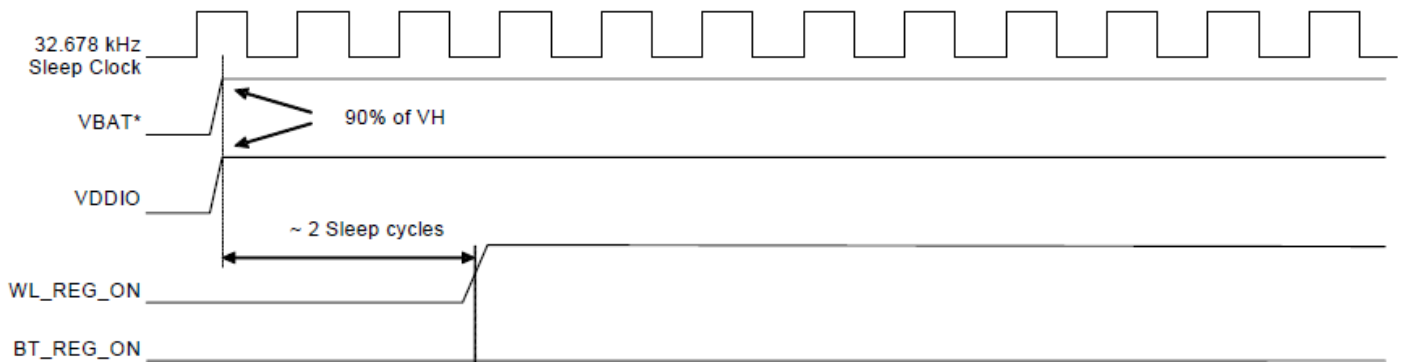

- *Notes:**
1. VBAT should not rise 10%–90% faster than 40 microseconds.
 2. VBAT should be up before or at the same time as VDDIO. VDDIO should NOT be present first or be held high before VBAT is high.

WLAN = ON, Bluetooth = OFF

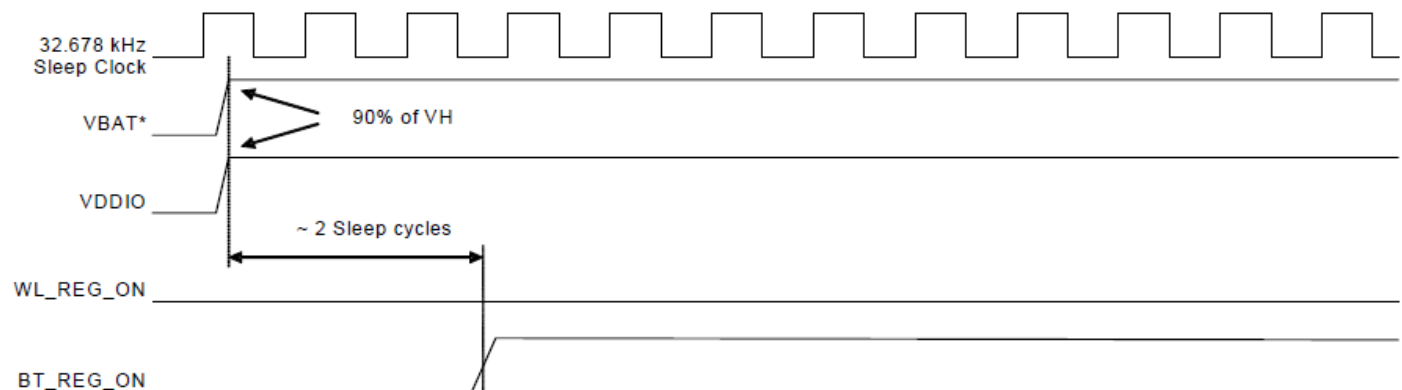

- *Notes:**
1. VBAT should not rise 10%–90% faster than 40 microseconds.
 2. VBAT should be up before or at the same time as VDDIO. VDDIO should NOT be present first or be held high before VBAT is high.

WLAN = OFF, Bluetooth = ON

3.6 Power Consumption*

3.6.1 WLAN

No.	Item			VBAT=3.3V(mA)		
				Max.	Avg.	
1	WLAN OFF ^{*(1)(2)}			0.002		
2	Sleep ^{*(2)(3)}			0.004	0.003	
3	Power Save DTIM1 (2.4GHz) ^{*(2) (4)(5)}			58	2.3	
5	Power Save DTIM1 (5GHz) ^{*(2)(4) (5)}			112	2.0	
Band (GHz)	Mode	BW (MHz)	RF Power (dBm)	Transmit		
				Max.	Avg.	Duty (%)
2.4	11b@1Mbps	20	17	318	310	93
	11g@54Mbps	20	15	121	119	25
	11n@MCS7	40	13	113	112	19
5	11a@54Mbps	20	15	138	136	25
	11n@MCS7	40	12	129	128	19
	11ac@MCS8 NSS1	80	8	131	129	10
Band (GHz)	Mode	BW(MHz)	Receive			
			Max.	Avg.		
2.4	11b@1Mbps	20	58	56		
	11n@MCS7	40	68	67		
5	11a@54Mbps	20	73	73		
	11ac@MCS8 NSS1	80	123	120		

No.	Item			VDDIO=1.8V(uA)	
				Max.	Avg.
1	WLAN OFF ^{*(1)}			0.021	
2	Sleep ^{*(3)}			249	249
3	Power Save DTIM1 (2.4GHz) ^{*(4) (6)}			252	213
Band (GHz)	Mode	BW (MHz)	RF Power (dBm)	Transmit	
				Max.	Avg.
2.4	11b@1Mbps	20	17	40	40
Band (GHz)	Mode	BW(MHz)	Receive		
			Max.	Avg.	
2.4	11b@1Mbps	20	40	40	

- (1) WLAN and Bluetooth OFF (WL_REG_ON=LOW, BT_REG_ON=LOW)
- (2) Using normal firmware
- (3) Run command "wifmac_x86 deepsleep 1" into sleep
- (4) Associated with AP use ASUS RT-AC66U, DTIM = 1, Beacon Interval = 100 ms
- (5) Run the following command and measured a current consumed across the DTIM duration
"wl mpc 1"
"wl PM 2"
"wl bcntrim 9"

* The power consumption is based on Azurewave test environment, these data for reference only.

3.6.2 Bluetooth

No.	Mode	Packet Type	RF Power (dBm)	VBAT=3.3 V	
				Max.	Avg.
1	Sleep	n/a	n/a	23mA	5.5uA
2	Transmit ^{*(1)}	DH5 / 3-DH5	8	41.2mA	40.2mA
3	Receive ^{*(1)}	DH5 / 3-DH5	n/a	14.6mA	14.5mA
No.	Mode	Packet Type	RF Power (dBm)	VBAT=1.8V	
				Max.	Avg.
1	Sleep	n/a	n/a	279uA	264uA
2	Transmit ^{*(1)}	DH5 / 3-DH5	8	19.8uA	19.8uA
3	Receive ^{*(1)}	DH5 / 3-DH5	n/a	19.9uA	19.8uA

(1) BlueTool BB_Packet_Length=65535

(2) BlueTool Length_of_Test_Data=37

* The power consumption is based on Azurewave test environment, these data for reference only.

4. Mechanical Information

4.1 Mechanical Drawing

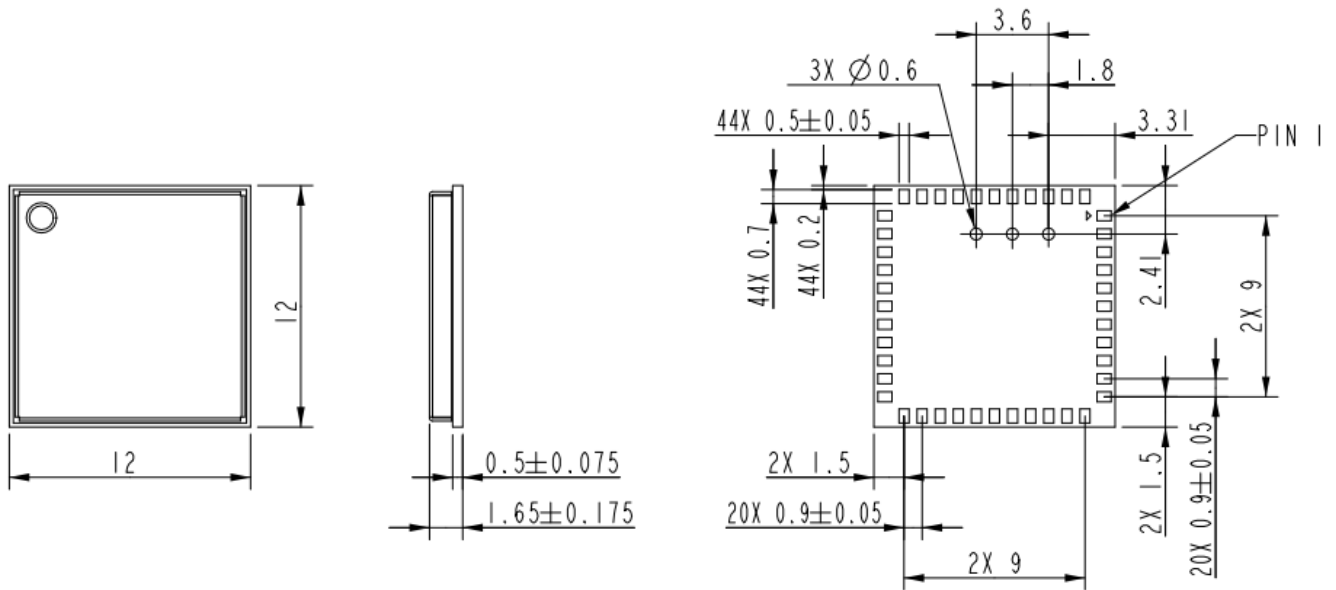
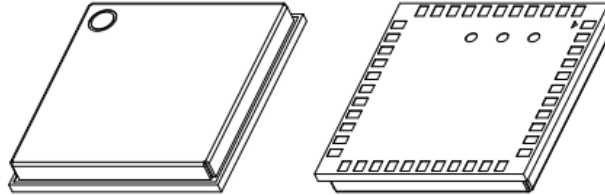

TOLERANCE UNLESS OTHERWISE SPECIFIED: ± 0.1 mm

5. Packaging Information

1. One reel can pack 1,500pcs 12x12 LGA modules
2. One production label is pasted on the reel, one desiccant and one humidity indicator card are put on the reel

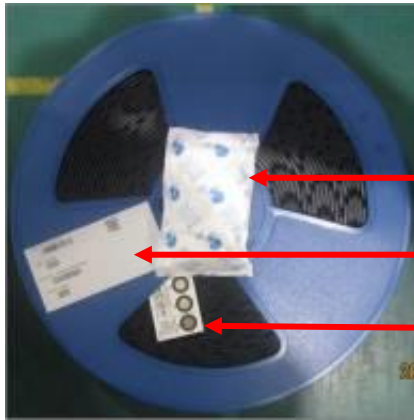

One desiccant

One production label

One humidity indicator card

3. One reel is put into the anti-static moisture barrier bag, and then one label is pasted on the bag



One production label

4. A bag is put into the anti-static pink bubble wrap

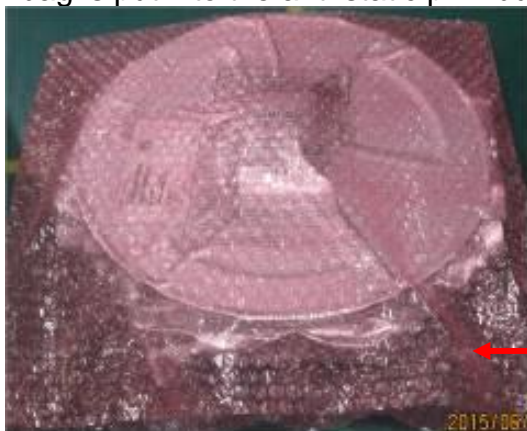

One anti-static pink bubble wrap

5. A bubble wrap is put into the inner box and then one label is pasted on the inner box

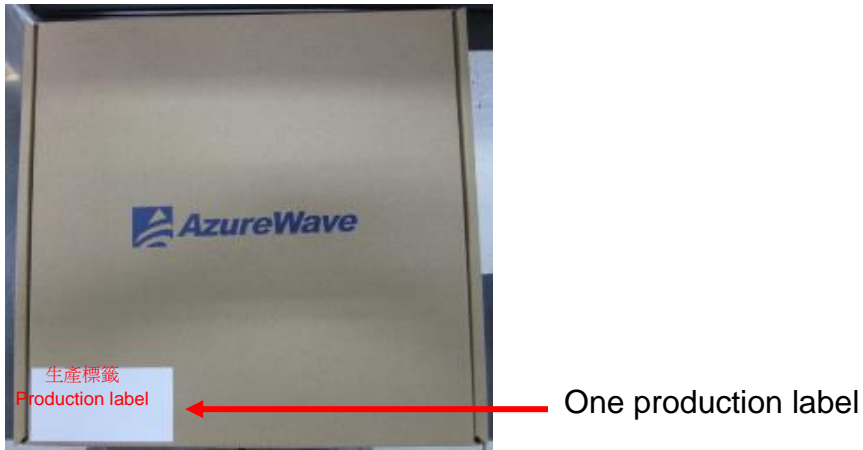

6. **5 inner boxes** could be put into one carton















7. Sealing the carton by AzureWave tape



8. One carton label and one box label are pasted on the carton. If one carton is not full, one balance label pasted on the carton



<p>Example of carton label</p>	 <table border="1" data-bbox="766 779 1281 1331"> <tr> <td colspan="2" style="text-align: center;"> AzureWave Technologies Inc.</td> </tr> <tr> <td>AzureWave P/N</td> <td></td> </tr> <tr> <td>Customer</td> <td>由業務提供</td> </tr> <tr> <td>Customer P/N</td> <td>由業務提供</td> </tr> <tr> <td>Customer PO</td> <td>由業務提供</td> </tr> <tr> <td>Description</td> <td>AW-XXXXXX</td> </tr> <tr> <td>QTY</td> <td>1200 pcs</td> </tr> <tr> <td>C/N</td> <td></td> </tr> <tr> <td>N.W.</td> <td>G.W.</td> </tr> <tr> <td colspan="2" style="text-align: center;"></td> </tr> </table>	 AzureWave Technologies Inc.		AzureWave P/N		Customer	由業務提供	Customer P/N	由業務提供	Customer PO	由業務提供	Description	AW-XXXXXX	QTY	1200 pcs	C/N		N.W.	G.W.		
 AzureWave Technologies Inc.																					
AzureWave P/N																					
Customer	由業務提供																				
Customer P/N	由業務提供																				
Customer PO	由業務提供																				
Description	AW-XXXXXX																				
QTY	1200 pcs																				
C/N																					
N.W.	G.W.																				
																					
<p>Example of box label</p>																					
<p>Example of production label</p>	 <p>P/N: </p> <p>D/C: 1309 </p> <p>PCK NO.: PCKNO0069097 </p> <p>QTY: 294 </p> <p>BAG SEAL DATE: _____</p>																				



Example of balance label	
--------------------------	--