

AW-XM458

IEEE 802.11 2X2 WiFi 6 SU and MU-MIMO DBC Wireless LAN + Bluetooth 5.3 Combo LGA Module

Datasheet

Rev. G

DF

For Standard

Features

WLAN

- ◆ Support 2x2 802.11 a/b/g/n/ac/ax
- ◆ Dual bands: 2.4 GHz and 5 GHz
 - ◆ Support 20/40/80 MHz channel Bandwidths.
- ◆ 5GHz PHY data rates up to 1.2 Gbps
- ◆ 2.4 GHz PHY data rates up to 458 Mbps
- ◆ Uplink and downlink OFDMA and MU-MIMO
- ◆ Instantaneous 0-DFS

WLAN Dual-Radios

- ◆ Dual, independent direct-conversion WLAN radios (with dual-MACs and dual-Basebands) supports true, simultaneous WLAN network operation at 2 different frequency bands,

Bluetooth

- ◆ Bluetooth 5.3
- ◆ Bluetooth class 2
- ◆ Bluetooth class 1
- ◆ PCM interface for voice applications
- ◆ 2Mbit/s LE
- ◆ Long range
- ◆ LTE/MWS coexistence
- ◆ 2 x wide band speech (WBS) calls
- ◆ Security: AES

Revision History

Document NO: R2-2458-DST-01

Version	Revision Date	DCN NO.	Description	Initials	Approved
A	2020/01/21	DCN019369	<ul style="list-style-type: none"> ● Draft version 	Renton Tao	N.C Chen
B	2021/12/01	DCN019370	<ul style="list-style-type: none"> ● Update pin out drawing ● Update product drawing ● Update RF spec(TX) 	Renton Tao	N.C Chen
C	2021/01/14	DCN020704	<ul style="list-style-type: none"> ● Update Bluetooth spec ● Update PCIE spec ● Update WiFi Rx spec ● Update Pin definition table ● Update operating temperature 	Renton Tao	N.C Chen
D	2021/05/17	DCN021907	<ul style="list-style-type: none"> ● Update WIFI spec description ● Update BT spec 	Roger Liu	N.C Chen
E	2021/05/28	DCN022153	<ul style="list-style-type: none"> ● Update power sequence ● Modify config table 	Roger Liu	N.C Chen
F	2021/07/30	DCN022853	<ul style="list-style-type: none"> ● Update power consumption ● Update BT sensitivity spec 	Roger Liu	N.C Chen
G	2021/11/10	DCN024101	<ul style="list-style-type: none"> ● Update BLE 1M spec ● Update BT spec. to 5.3 	Roger Liu	N.C Chen

Table of Contents

Revision History	3
DCN019369.....	3
DCN019370.....	3
Table of Contents	4
1. Introduction	5
1.1 Product Overview	5
1.2 Block Diagram	6
1.3 Specifications Table	7
1.3.1 General.....	7
1.3.2 WLAN.....	7
1.3.3 Bluetooth.....	9
1.3.4 Operating Conditions.....	10
2.1 Pin Map	11
2.2 Pin Table	12
2.3 Host Configuration Interface Table	14
3. Electrical Characteristics	15
3.1 Absolute Maximum Ratings	15
3.2 Recommended Operating Conditions	15
3.3 Digital IO Pin DC Characteristics	15
3.3.1 1.8V Operation (VIO).....	15
3.3.2 3.3V Operation (VIO).....	16
3.3.3 1.8V Operation (VIO_SD).....	16
3.3.4 3.3V Operation (VIO_SD).....	16
3.4 Host Interface	17
3.4.1 SDIO Interface.....	17
3.4.2 SDIO Protocol Timing.....	18
3.4.3 PCI Express Interface.....	23
3.4.5.High-Speed UART Interface.....	25
3.4.6 PCM Interface.....	26
3.5 Timing Sequence	28
3.6 Power Consumption*	29
3.6.1 WLAN.....	29
3.6.2 Bluetooth.....	30
4. Mechanical Information	31
4.1 Mechanical Drawing	31
5. Packing Information	32

1. Introduction

1.1 Product Overview

AzureWave Technologies, Inc. introduces the IEEE 802.11a/b/g/n/ac/ax Concurrent Dual WiFi(CDW) and BT, combo module – **AW-XM458**. With High Efficiency Wireless(HEW) and backward compatible with 802.11ac technologies integrated into a module, AW-XM458 provides the best and most convenient SMT process. The module is targeted to mobile devices including, Tablet PC, Portable Media Players (PMPs), Portable Navigation Devices (PNDs), Personal Digital Assistants (PDAs), Tracking Devices, Gaming Devices which need convenient SMT process, low power consumption.

By using AW-XM458, the customers can easily integrate the Wi-Fi, BT, by a combo module with the benefits of **high design flexibility, high success rate on SMT process, short development cycle, and quick time-to-market.**

Compliance with the IEEE 802.11a/b/g/n/ac/ax standard, the AW-XM458 uses **DSSS, OFDM, DBPSK, DQPSK, CCK** and **QAM** baseband modulation technologies. A high level of integration and full implementation of the power management functions specified in the IEEE 802.11 standard minimize the system power requirements by using AW-XM458.

The AW-XM458 supports standard interface **PCIe or SDIO for WLAN** interface connection and High-Speed **UART or SDIO for BT** interface connection. AW-XM458 is suitable for multiple mobile processors for different applications. With the combo functions and the good performance, the AW-XM458 is the best solution for the consumer electronics and the tablet PC.

Scenario	2.4GHz Band			5GHz Band		
	Mode	Technology	BW	Mode	Technology	BW
1	2x2	802.11n	40MHz	2x2	802.11ax	80MHz
2	2x2	802.11n	40MHz	1x1	802.11ax	80MHz
				1Rx	Zero Wait DFS	80MHz
3	2x2	802.11ax	40MHz	2x2	802.11ac	40MHz

Concurrent 2.4GHz and 5GHz modes supported table

1.2 Block Diagram

A simplified block diagram of the AW-XM458 module is depicted in the figure below.

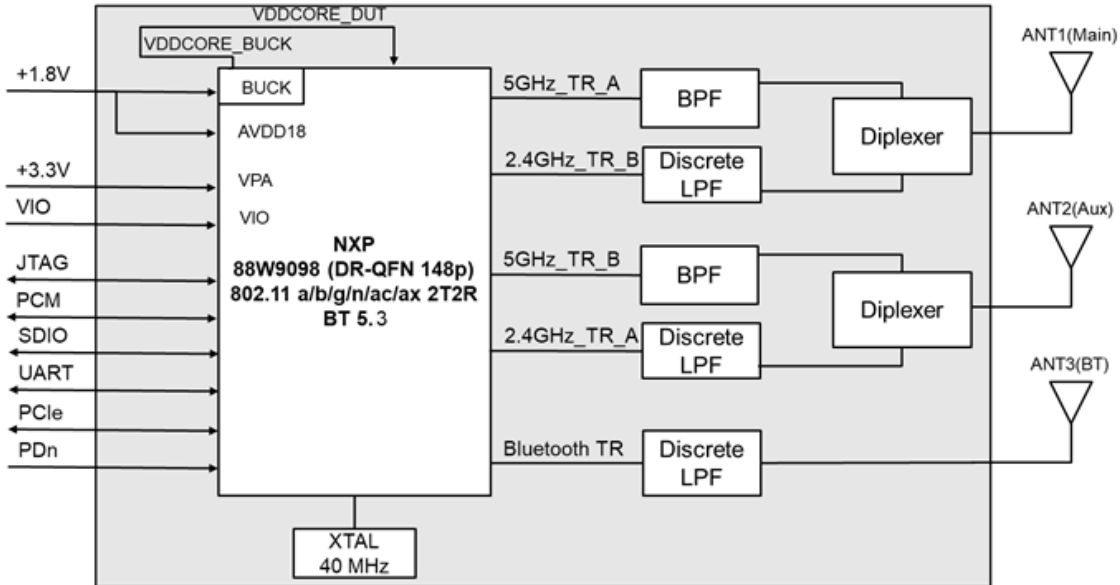

AW-XM458 Block Diagram

1.3 Specifications Table

1.3.1 General

Features	Description
Product Description	IEEE 802.11 2X2 WiFi 6 MIMO Wireless LAN + Bluetooth 5.3 Combo LGA Module
Major Chipset	NXP 88W9098 (DR-QFN 148pin)
Host Interface	WiFi + BT <ul style="list-style-type: none"> ● PCIe2.0 + UART ● SDIO3.0 + UART (For Host configuration interface, please refer to section 2.3)
Dimension	20 mm X 18 mm x 2.8 mm (Tolerance remarked in mechanical drawing)
Form factor	LGA module, 98 pins
Antenna	2T2R for WiFi, standalone antenna for BT ANT1(Main) : WiFi_A → TX/RX ANT2(Aux) : WiFi_B → TX/RX ANT3(BT): BT
Weight	0.0019kg

1.3.2 WLAN

Features	Description
WLAN Standard	IEEE 802.11 a/b/g/n/ac/ax 2T2R
WLAN VID/PID	
WLAN SVID/SPID	TBD
Frequency Range	2.4 GHz ISM Bands 2.412-2.472 GHz 5.15-5.25 GHz (FCC UNII-low band) for US/Canada and Europe 5.25-5.35 GHz (FCC UNII-middle band) for US/Canada and Europe 5.47-5.725 GHz for Europe 5.725-5.825 GHz (FCC UNII-high band) for US/Canada
Modulation	DSSS, OFDM, DBPSK, DQPSK, CCK, 16-QAM, 64-QAM, 256QAM, 1024QAM, OFDMA
Number of Channels	2.4GHz: <ul style="list-style-type: none"> ■ USA, NORTH AMERICA, Canada and Taiwan - 1 ~ 11 ■ China, Australia, Most European Countries - 1 ~ 13 ■ Japan, 1 ~ 13

	<p>5GHz:</p> <ul style="list-style-type: none"> ■ USA, Canada, Most European Countries - 36,40,44,48,52,56,60,64,100,104,108,112,116,120,124,128,132,136,140,149,153,157,161,165 ■ Japan - 36,40,44,48,52,56,60,64,100,104,108,112,116,120,124,128,132,136,140 ■ China - 36,40,44,48,52,56,60,64, 149,153,157,161,165 																																																																																					
Output Power (RF specifications are at 25°C)	<p>2.4G</p> <table border="1" data-bbox="500 573 1484 1064"> <thead> <tr> <th></th> <th>Min</th> <th>Typ</th> <th>Max</th> <th>Unit</th> </tr> </thead> <tbody> <tr> <td>11b (11Mbps) @EVM<35%</td> <td>16</td> <td>18</td> <td>20</td> <td>dBm</td> </tr> <tr> <td>11g (54Mbps) @EVM≤-27 dB</td> <td>15.5</td> <td>17</td> <td>18.5</td> <td>dBm</td> </tr> <tr> <td>11n (HT20 MCS7) @EVM≤-28 dB</td> <td>14.5</td> <td>16</td> <td>17.5</td> <td>dBm</td> </tr> <tr> <td>11n (HT40 MCS7) @EVM≤-28 dB</td> <td>14.5</td> <td>16</td> <td>17.5</td> <td>dBm</td> </tr> <tr> <td>11ax (HE20 MCS11) @EVM≤-35 dB</td> <td>12.5</td> <td>14</td> <td>15.5</td> <td>dBm</td> </tr> <tr> <td>11ax (HE40 MCS11) @EVM≤-35 dB</td> <td>12.5</td> <td>14</td> <td>15.5</td> <td>dBm</td> </tr> </tbody> </table> <p>5G</p> <table border="1" data-bbox="500 1123 1484 1837"> <thead> <tr> <th></th> <th>Min</th> <th>Typ</th> <th>Max</th> <th>Unit</th> </tr> </thead> <tbody> <tr> <td>11a (54Mbps) @EVM≤-27 dB</td> <td>14</td> <td>16</td> <td>18</td> <td>dBm</td> </tr> <tr> <td>11n (HT20 MCS7) @EVM≤-28 dB</td> <td>14</td> <td>16</td> <td>18</td> <td>dBm</td> </tr> <tr> <td>11n (HT40 MCS7) @EVM≤-28 dB</td> <td>14</td> <td>16</td> <td>18</td> <td>dBm</td> </tr> <tr> <td>11ac(VHT20 MCS8) @EVM≤-31 dB</td> <td>13</td> <td>15</td> <td>17</td> <td>dBm</td> </tr> <tr> <td>11ac(VHT40 MCS9) @EVM≤-32 dB</td> <td>13</td> <td>15</td> <td>17</td> <td>dBm</td> </tr> <tr> <td>11ac(VHT80 MCS9) @EVM≤-32 dB</td> <td>13</td> <td>15</td> <td>17</td> <td>dBm</td> </tr> <tr> <td>11ax(HE20 MCS11) @EVM≤-35 dB</td> <td>10</td> <td>12</td> <td>14</td> <td>dBm</td> </tr> <tr> <td>11ax(HE40 MCS11) @EVM≤-35 dB</td> <td>10</td> <td>12</td> <td>14</td> <td>dBm</td> </tr> <tr> <td>11ax(HE80 MCS11) @EVM≤-35 dB</td> <td>10</td> <td>12</td> <td>14</td> <td>dBm</td> </tr> </tbody> </table>		Min	Typ	Max	Unit	11b (11Mbps) @EVM<35%	16	18	20	dBm	11g (54Mbps) @EVM≤-27 dB	15.5	17	18.5	dBm	11n (HT20 MCS7) @EVM≤-28 dB	14.5	16	17.5	dBm	11n (HT40 MCS7) @EVM≤-28 dB	14.5	16	17.5	dBm	11ax (HE20 MCS11) @EVM≤-35 dB	12.5	14	15.5	dBm	11ax (HE40 MCS11) @EVM≤-35 dB	12.5	14	15.5	dBm		Min	Typ	Max	Unit	11a (54Mbps) @EVM≤-27 dB	14	16	18	dBm	11n (HT20 MCS7) @EVM≤-28 dB	14	16	18	dBm	11n (HT40 MCS7) @EVM≤-28 dB	14	16	18	dBm	11ac(VHT20 MCS8) @EVM≤-31 dB	13	15	17	dBm	11ac(VHT40 MCS9) @EVM≤-32 dB	13	15	17	dBm	11ac(VHT80 MCS9) @EVM≤-32 dB	13	15	17	dBm	11ax(HE20 MCS11) @EVM≤-35 dB	10	12	14	dBm	11ax(HE40 MCS11) @EVM≤-35 dB	10	12	14	dBm	11ax(HE80 MCS11) @EVM≤-35 dB	10	12	14	dBm
	Min	Typ	Max	Unit																																																																																		
11b (11Mbps) @EVM<35%	16	18	20	dBm																																																																																		
11g (54Mbps) @EVM≤-27 dB	15.5	17	18.5	dBm																																																																																		
11n (HT20 MCS7) @EVM≤-28 dB	14.5	16	17.5	dBm																																																																																		
11n (HT40 MCS7) @EVM≤-28 dB	14.5	16	17.5	dBm																																																																																		
11ax (HE20 MCS11) @EVM≤-35 dB	12.5	14	15.5	dBm																																																																																		
11ax (HE40 MCS11) @EVM≤-35 dB	12.5	14	15.5	dBm																																																																																		
	Min	Typ	Max	Unit																																																																																		
11a (54Mbps) @EVM≤-27 dB	14	16	18	dBm																																																																																		
11n (HT20 MCS7) @EVM≤-28 dB	14	16	18	dBm																																																																																		
11n (HT40 MCS7) @EVM≤-28 dB	14	16	18	dBm																																																																																		
11ac(VHT20 MCS8) @EVM≤-31 dB	13	15	17	dBm																																																																																		
11ac(VHT40 MCS9) @EVM≤-32 dB	13	15	17	dBm																																																																																		
11ac(VHT80 MCS9) @EVM≤-32 dB	13	15	17	dBm																																																																																		
11ax(HE20 MCS11) @EVM≤-35 dB	10	12	14	dBm																																																																																		
11ax(HE40 MCS11) @EVM≤-35 dB	10	12	14	dBm																																																																																		
11ax(HE80 MCS11) @EVM≤-35 dB	10	12	14	dBm																																																																																		

Receiver Sensitivity (RF specifications are at 25°C)	2.4G				
		Min	Typ	Max	Unit
	11b (11Mbps)	-	-88	-85	dBm
	11g (54Mbps)	-	-75	-72	dBm
	11n (HT20 MCS7)	-	-72	-69	dBm
	11n (HT40 MCS7)	-	-70	-66	dBm
	11ax(HE20 MCS11)	-	-62	-58	dBm
	11ax(HE40 MCS11)	-	-59	-53	dBm
	5G				
		Min	Typ	Max	Unit
	11a (54Mbps)	-	-72	-68	dBm
	11n (HT20 MCS7)	-	-70	-66	dBm
	11n (HT40 MCS7)	-	-68	-64	dBm
	11ac(VHT20 MCS8)	-	-65	-61	dBm
	11ac(VHT40 MCS9)	-	-62	-58	dBm
	11ac(VHT80 MCS9)	-	-59	-55	dBm
	11ax(HE20 MCS11)	-	-60	-56	dBm
	11ax(HE40 MCS11)	-	-57	-53	dBm
	11ax(HE80 MCS11)	-	-55	-51	dBm
Data Rate	<ul style="list-style-type: none"> ■ 802.11b: 1, 2, 5.5, 11Mbps ■ 802.11a/g: 6, 9, 12, 18, 24, 36, 48, 54Mbps ■ 802.11n: up to 150Mbps-single ■ 802.11n: up to 300Mbps-2x2 MIMO ■ 802.11ac: up to 192.6Mbps (20MHz channel) ■ 802.11ac: up to 400Mbps (40MHz channel) ■ 802.11ac: up to 866.7Mbps (80MHz channel) ■ 802.11ax: 2.4GHz up to 458Mbps, 5GHz up to 1.2Gbps 				
Security	WiFi: WPA/WPA2/WPA3				

* If you have any certification questions about output power please contact FAE directly.

1.3.3 Bluetooth

Features	Description
Bluetooth Standard	Bluetooth 5.3
Bluetooth VID/PID	N/A
Frequency Range	2402MHz~2483MHz
Modulation	Header GFSK Payload 2M: $\pi/4$ -DQPSK

Payload 3M: 8DPSK					
Output Power		Min	Typ	Max	Unit
	BDR	0	2	4	dBm
	EDR	0	2	4	dBm
	Low Energy (1MHz)	0	2	4	dBm
	Low Energy (2MHz)	0	2	4	dBm
*Receiver Sensitivity		Min	Typ	Max	Unit
	BDR	-	-90	-87	dBm
	EDR	-	-87	-84	dBm
	Low Energy (1MHz)	-	-86	-83	dBm
	Low Energy (2MHz)	-	-85	-82	dBm

*Except for BT channel 38/78.

1.3.4 Operating Conditions

Features	Description
Operating Conditions	
Voltage	3.3V+5%
Operating Temperature	-40 °C~ 85°C
Operating Humidity	less than 85% R.H.
Storage Temperature	-40 °C~ 85°C
Storage Humidity	less than 60% R.H.
ESD Protection	
Human Body Model	+2kV
Changed Device Model	+500V

2.1 Pin Map

AW-XM458 pin out drawing (top view).

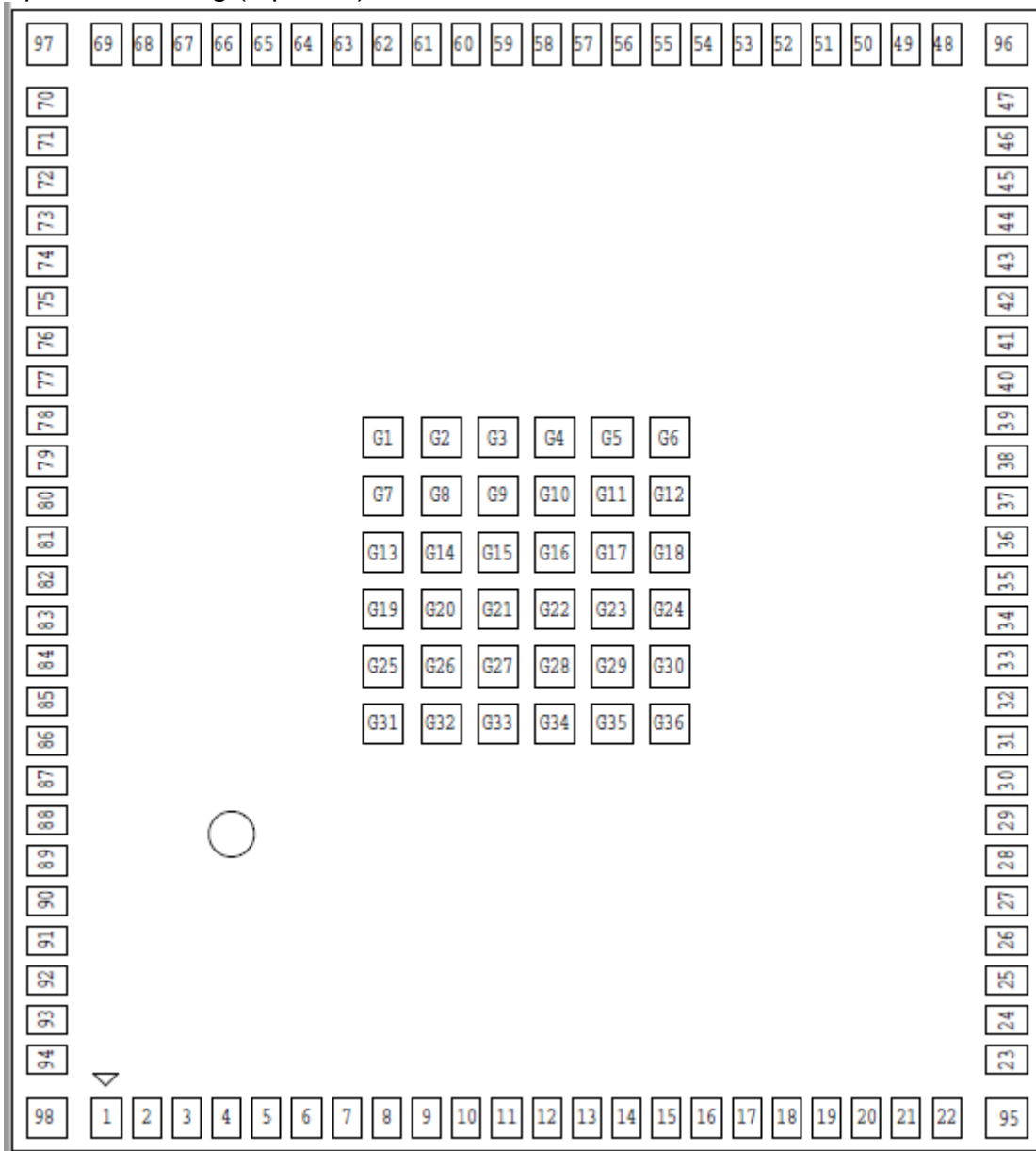

2.2 Pin Table

Pin No	Definition	Basic Description	Voltage	Type
1	PCM_OUT	PCM_OUT, GPIO Mode : GPIO[5].	VDDIO	I/O
2	PCM_CLK	PCM_CLK, GPIO Mode : GPIO[6].	VDDIO	I/O
3	GPIO[1]	GPIO Mode : GPIO[1].	VDDIO	I/O
4	GND	Ground	---	---
5	PCIE_RCLK_P	PCI Express Differential Clock Input—Positive	1V8	I
6	PCIE_RCLK_N	PCI Express Differential Clock Input—Negative	1V8	I
7	GND	Ground	---	---
8	PCIE_TX_P	PCI Express Transmit Data—Positive	1V8	O
9	PCIE_TX_N	PCI Express Transmit Data—Negative	1V8	O
10	GND	Ground	---	---
11	PCIE_RX_N	PCI Express Receive Data—Negative	1V8	I
12	PCIE_RX_P	PCI Express Receive Data—Positive	1V8	I
13	GND	Ground	---	---
14	DNC	DNC	---	---
15	DNC	DNC	---	---
16	GND	Ground	---	---
17	SD_DAT[3]	SDIO Data line Bit[3]	VIO_SD	I/O
18	SD_DAT[2]	SDIO Data line Bit[2]	VIO_SD	I/O
19	SD_DAT[1]	SDIO Data line Bit[1]	VIO_SD	I/O
20	SD_DAT[0]	SDIO Data line Bit[0]	VIO_SD	I/O
21	SD_CMD	SDIO Command/response (input/output)	VIO_SD	I/O
22	SD_CLK	SDIO Clock input	VIO_SD	I
23	VIO_SD	1.8V/3.3V Digital I/O SDIO Power Supply	1.8 or 3.3V	I
24	GND	Ground	---	---
25	PCIE_PERSTn	PCIe host indication to reset the device (active low)	VIO	I
26	PCIE_CLKREQn	PCIe clock request (active low)	VIO	I/O
27	PCIE_WAKEn	PCIe wake signal (active low)	VIO	I/O
28	PCIE_DISABLEn	PCIe DISABLEn(active low)	VIO	I
29	GND	Ground	---	---
30	UART_RTSn	UART Mode: UART_RTSn (active low)	VDDIO	O
31	UART_CTSn	UART Mode: UART_CTSn (active low)	VDDIO	I
32	UART_RX	UART SIN pin	VDDIO	I
33	UART_TX	UART SOUT.pin	VDDIO	O
34	GPIO[12]	GPIO Mode : GPIO[12].	VDDIO	I/O
35	GPIO[13]	GPIO Mode : GPIO[13].	VDDIO	I/O
36	JTAG_TDO	JTAG_TDO/GPIO[31]	VDDIO	I/O
37	JTAG_TMS	JTAG_TMS/GPIO[29]	VDDIO	I/O
38	JTAG_TDI	JTAG_TDI/GPIO[30]	VDDIO	I/O
39	JTAG_TCK	JTAG_TCK/GPIO[28]	VDDIO	I/O
40	NC	NC	---	floating

41	NC	NC	---	floating
42	NC	NC	---	floating
43	NC	NC	---	floating
44	NC	NC	---	floating
45	NC	NC	---	floating
46	NC	NC	---	floating
47	NC	NC	---	floating
48	ANT3	RF I/O pad for BT	---	I/O
49	GND	Ground	---	---
50	GND	Ground	---	---
51	GND	Ground	---	---
52	ANT2	RF I/O pad for WLAN ANT 2	---	I/O
53	GND	Ground	---	---
54	GND	Ground	---	---
55	GND	Ground	---	---
56	GND	Ground	---	---
57	GND	Ground	---	---
58	GND	Ground	---	---
59	GND	Ground	---	---
60	GND	Ground	---	---
61	GND	Ground	---	---
62	GND	Ground	---	---
63	GND	Ground	---	---
64	GND	Ground	---	---
65	GND	Ground	---	---
66	GND	Ground	---	---
67	GND	Ground	---	---
68	GND	Ground	---	---
69	ANT1	RF I/O pad for WLAN ANT 1	---	I/O
70	3V3	3.3V DC power supply	3.3V	I
71	3V3	3.3V DC power supply	3.3V	I
72	GND	Ground	---	---
73	CON[0]	Firmware Boot Options. See below table*	VIO	I
74	CON[1]	Firmware Boot Options. See below table*	VIO	I
75	CON[2]	Firmware Boot Options. See below table*	VIO	I
76	NC	NC	---	floating
77	NC	NC	---	floating
78	NC	NC	---	floating
79	NC	NC	---	floating
80	NC	NC	---	floating
81	GPIO[18]	GPIO Mode : GPIO[18].	VDDIO	I/O
82	GPIO[19]	GPIO Mode : GPIO[19].	VDDIO	I/O
83	GND	Ground	---	---
84	PDn	Full Power-down input pin (active low)	3V3	I

		0 = full power-down mode 1 = normal mode		
85	GPIO[0]	GPIO Mode : GPIO[0].	VDDIO	I/O
86	GPIO[14]*	CON[4]* / GPIO[14]	VDDIO	I/O
87	GPIO[15]	GPIO Mode : GPIO[15].	VDDIO	I/O
88	GPIO[16]	GPIO Mode : GPIO[16].	VDDIO	I/O
89	PCM_SYNC	PCM_SYNC, GPIO Mode : GPIO[7].	VDDIO	I/O
90	VIO	Digital I/O power supply	1.8 or 3.3V	I
91	GND	Ground	---	---
92	1V8	1.8V DC power supply	1.8V	I
93	1V8	1.8V DC power supply	1.8V	I
94	PCM_DIN	PCM_DIN, GPIO Mode : GPIO[4].	VDDIO	I/O
95	GND	Ground	---	---
96	GND	Ground	---	---
97	GND	Ground	---	---
98	GND	Ground	---	---
G1~36	GND	Ground	---	---

*Due to CON[4] strap function, need to pull down with 51k resistor external

2.3 Host Configuration Interface Table

*Firmware Boot options

Strap Value	WLAN	Bluetooth/LE
000	SDIO	UART
011	PCIe	UART

3. Electrical Characteristics

3.1 Absolute Maximum Ratings

Symbol	Parameter	Minimum	Typical	Maximum	Unit
3V3	DC supply for the 3.3V input	-	3.3	3.63	V
1V8	DC supply for the 1.8V input		1.8	2.16	
VIO	I/O power supply	-	3.3	3.63	V
		-	1.8	1.98	
VIO_SD	SDIO power supply	-	3.3	3.63	V
		-	1.8	1.98	

3.2 Recommended Operating Conditions

Symbol	Parameter	Minimum	Typical	Maximum	Unit
3.3V	DC supply for the 3.3V input	3.14	3.3	3.46	V
1V8	DC supply for the 1.8V input	1.71	1.8	1.89	V
VIO	1.8V/3.3V digital I/O power supply	3.14	3.3	3.46	V
		1.71	1.8	1.89	
VIO_SD	1.8V/3.3V SDIO power supply	3.14	3.3	3.46	V
		1.71	1.8	1.89	

3.3 Digital IO Pin DC Characteristics

3.3.1 1.8V Operation (VIO)

Symbol	Parameter	Minimum	Typical	Maximum	Unit
V _{IH}	Input high voltage	0.7*VIO	-	VIO+0.4	V
V _{IL}	Input low voltage	-0.4	-	0.3*VIO	
V _{OH}	Output high voltage	VIO-0.4	-	-	
V _{OL}	Output low voltage	-	-	0.4	
V _{HYS}	Input Hysteresis	100			mV

3.3.2 3.3V Operation (VIO)

Symbol	Parameter	Minimum	Typical	Maximum	Unit
V _{IH}	Input high voltage	0.7*VIO	-	VIO+0.4	V
V _{IL}	Input low voltage	-0.4	-	0.3*VIO	
V _{OH}	Output High Voltage	VIO-0.4	-	-	
V _{OL}	Output Low Voltage	-	-	0.4	
V _{HYS}	Input Hysteresis	100			mV

3.3.3 1.8V Operation (VIO_SD)

Symbol	Parameter	Minimum	Typical	Maximum	Unit
V _{IH}	Input high voltage	0.7*VIO_SD	-	VIO_SD+0.4	V
V _{IL}	Input low voltage	-0.4	-	0.3*VIO_SD	
V _{OH}	Output High Voltage	VIO_SD-0.4	-	-	
V _{OL}	Output Low Voltage	-	-	0.4	
V _{HYS}	Input Hysteresis	100			mV

3.3.4 3.3V Operation (VIO_SD)

Symbol	Parameter	Minimum	Typical	Maximum	Unit
V _{IH}	Input high voltage	0.7*VIO_SD	-	VIO_SD+0.4	V
V _{IL}	Input low voltage	-0.4	-	0.3* VIO_SD	
V _{OH}	Output High Voltage	VIO_SD-0.4	-	-	
V _{OL}	Output Low Voltage	-	-	0.4	
V _{HYS}	Input Hysteresis	100			mV

3.4 Host Interface

3.4.1 SDIO Interface

The AW-XM458 supports a SDIO device interface that conforms to the industry SDIO Full-Speed card specification and allows a host controller using the SDIO bus protocol to access the Wireless SoC device.

The AW-XM458 acts as the device on the SDIO bus. The host unit can access registers of the SDIO interface directly and can access shared memory in the device through the use of BARs and a DMA engine.

- ◆ Support SDIO 3.0 Standard.
- ◆ On-chip memory used for CIS.
- ◆ Supports 4-bit SDIO and 1-bit SDIO transfer modes.
- ◆ Special interrupt register for information exchange.
- ◆ Allows card to interrupt host.

SDIO Interface Signals

AW-XM458 SDIO Pin Name	Type	Description
SDIO_DATA_CLK	I	SDIO 4-bit mode: Clock SDIO 1-bit mode: Clock
SDIO_DATA_CMD	I/O	SDIO 4-bit mode: Command line SDIO 1-bit mode: Command line
SDIO_DATA_3	I/O	SDIO 4-bit mode: Data line Bit[3] SDIO 1-bit mode: Not used
SDIO_DATA_2	I/O	SDIO 4-bit mode: Data line Bit[2] or Read Wait (optional) SDIO 1-bit mode: Read Wait (optional)
SDIO_DATA_1	I/O	SDIO 4-bit mode: Data line Bit[1] SDIO 1-bit mode: Interrupt
SDIO_DATA_0	I/O	SDIO 4-bit mode: Data line Bit[0] SDIO 1-bit mode: Data line

3.4.2 SDIO Protocol Timing

3.4.2.1 Default Speed, High-Speed Modes (3.3V)

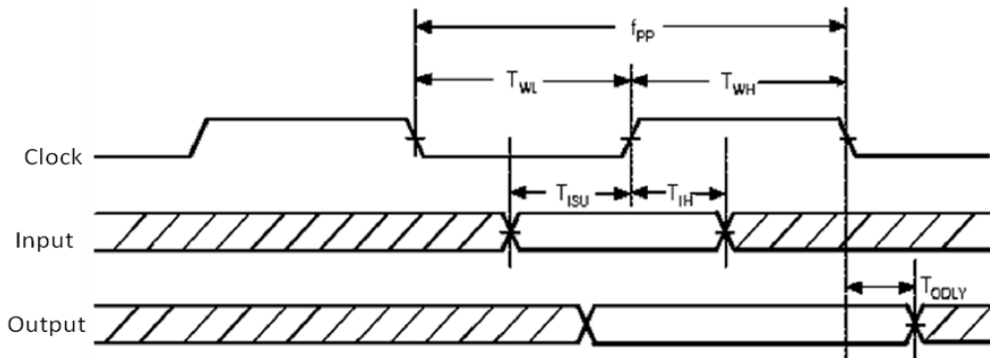

SDIO protocol timing Diagram - Default mode. (3.3V)

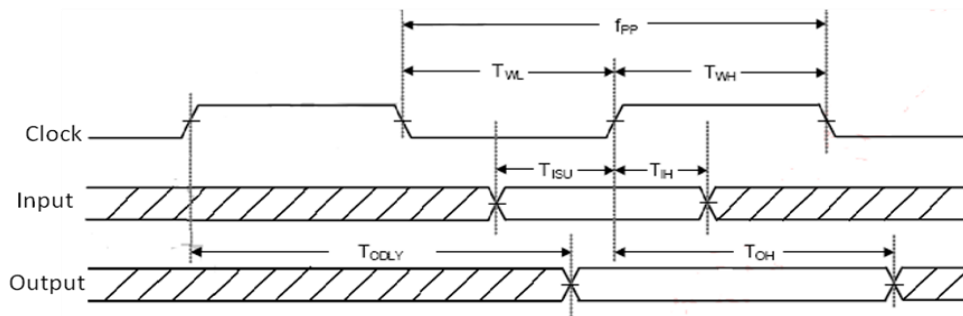

SDIO protocol timing Diagram - High Speed mode. (3.3V)

Symbol	Parameter	Condition	Min	Typ	Max	Units
f _{pp}	CLK Frequency	Normal	0	--	25	MHz
		High Speed	0	--	50	MHz
T _{WH}	CLK High Time	Normal	10	--	--	ns
		High Speed	7	--	--	ns
T _{WL}	CLK Low Time	Normal	10	--	--	ns
		High Speed	7	--	--	ns
T _{ISU}	Input Setup Time	Normal	5	--	--	ns
		High Speed	6	--	--	ns
T _{IH}	Input Hold Time	Normal	5	--	--	ns
		High Speed	2	--	--	ns
T _{ODLY}	Output Delay Time	Normal	--	--	14	ns
	CL ≤ 40pF (1 card)	High Speed	--	--	14	ns
T _{OH}	Output Hold Time	High Speed	2.5	--	--	ns

SDIO Timing Data – Default Speed / High-Speed modes. (3.3V)

3.4.2.2 SDR12, SDR25, SDR50 Modes (up to 100MHz) (1.8V)

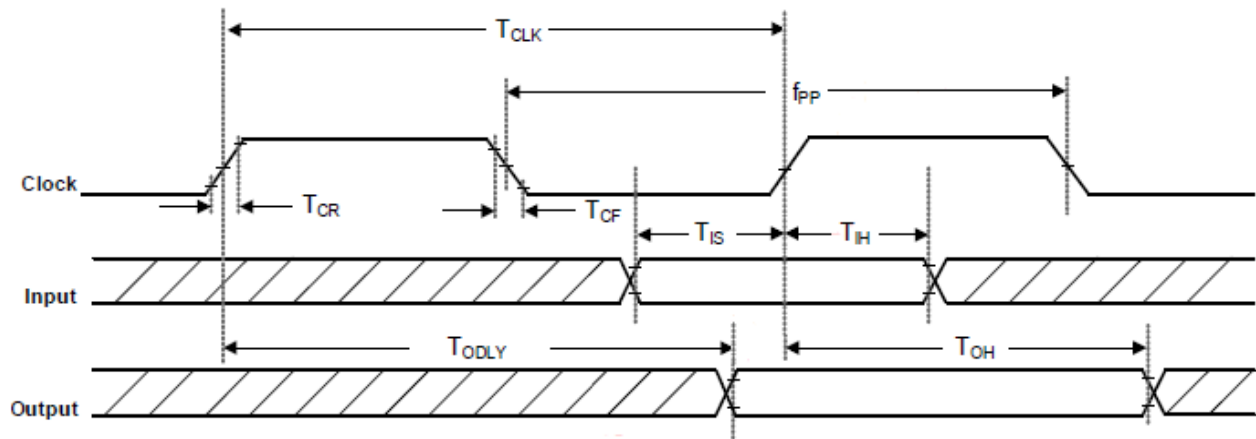

SDIO Protocol Timing Diagram - SDR12, SDR25, SDR50 Modes (up to 100 MHz)(1.8V)

Symbol	Parameter	Condition	Min	Typ	Max	Units
F_{pp}	CLK Frequency	SDR12/25/50	25	-	100	MHz
T_{CLK}	Clock Time	SDR12/25/50	10	-	40	ns
T_{IS}	Input Setup Time	SDR12/25/50	3	-	-	ns
T_{IH}	Input Hold Time	SDR12/25/50	0.8	-	-	ns
T_{CR}, T_{CF}	Rise time, fall time TCR, TCF < 2ns(max) at 100MHz CCARD = 10pF	SDR12/25/50	-	-	$0.2 * T_{CLK}$	ns
T_{ODLY}	Output Delay Time $CL \leq 30pF$	SDR12/25/50	-	-	7.5	ns
T_{OH}	Output Hold Time $CL = 15pF$	SDR12/25/50	1.5	-	-	ns

SDIO Timing Data - SDR12/25/50 modes. (1.8V)

3.4.2.3 SDR104 Mode (208MHz) (1.8V)

SDIO Protocol Timing Diagram –SDR104 Mode (208MHz)

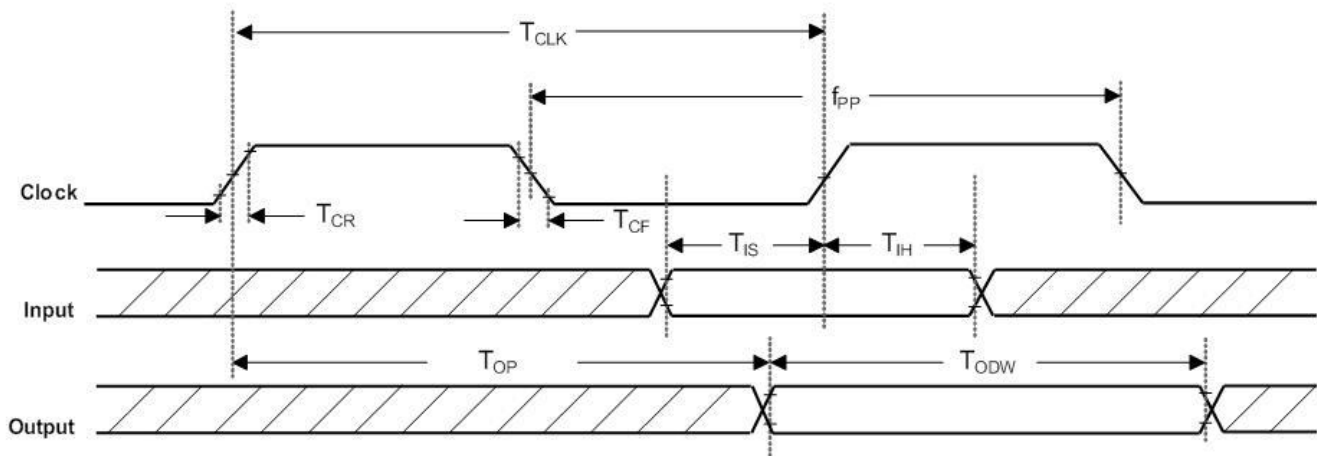
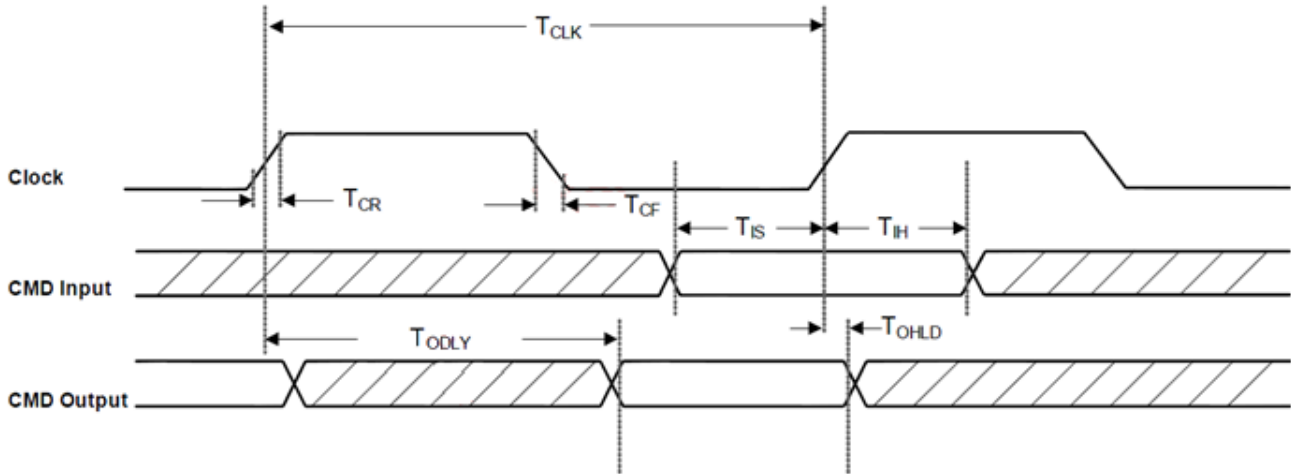

Table shows SDIO Timing Data—SDR104 Mode (208MHz)

Symbol	Parameter	Condition	Min	Typ	Max	Units
f_{pp}	CLK Frequency	SDR104	0	-	208	MHz
T_{CLK}	Clock Time	SDR104	4.8	-	-	ns
T_{IS}	Input Setup Time	SDR104	1.4	-	-	ns
T_{IH}	Input Hold Time	SDR104	0.8	-	-	ns
T_{CR}, T_{CF}	Rise time, fall time $T_{CR}, T_{CF} < 0.96\text{ns}(\text{max})$ at 208MHz $C_{CARD}=10\text{pF}$	SDR104	-	-	$0.2 \cdot T_{CLK}$	ns
T_{OP}	Card output phase	SDR104	0	-	10	ns
T_{ODW}	Output timing of variable data window	SDR104	2.88	-	-	ns

3.4.2.4 DDR50 Mode (50MHz) (1.8V)



SDIO CMD Timing Diagram - DDR50 Mode (50 MHz)

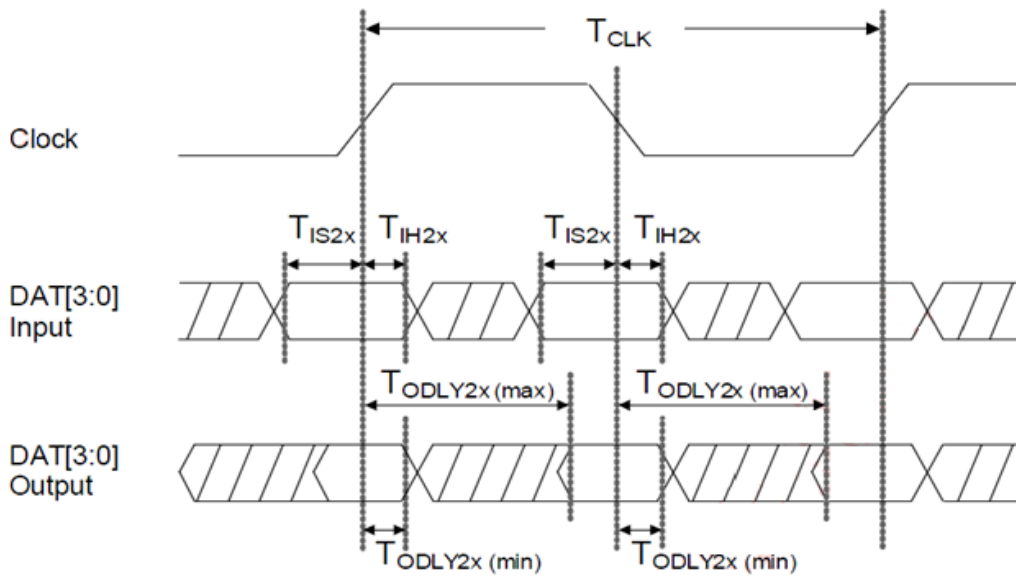

SDIO DAT[3:0] Timing Diagram - DDR50 Mode¹ (50 MHz)

¹ In DDR50 mode, DAT[3:0] lines are sampled on both edges of the clock (not applicable for CMD line).

Symbol	Parameter	Condition	Min	Typ	Max	Units
Clock						
T _{CLK}	Clock time	DDR50	20	-	-	ns
T _{CR} , T _{CF}	Rise time, fall time	DDR50	-	-	0.2*T _{CLK}	Ns
Clock Duty		DDR50	45	-	55	%
CMD Input						
T _{IS}	Input setup time	DDR50	6	-	-	ns
T _{IH}	Input hold time	DDR50	0.8	-	-	ns
CMD Output						
T _{ODLY}	Output delay time during data transfer mode	DDR50	-	-	13.7	ns
T _{OHLd}	Output hold time	DDR50	1.5	-	-	ns
DAT [3:0] Input						
T _{IS2X}	Input setup time	DDR50	3	-	-	ns
T _{IH2X}	Input hold time	DDR50	0.8	-	-	ns
DAT [3:0] Output						
T _{ODLY2X(max)}	Output delay time during data transfer mode	DDR50	-	-	7	ns
T _{ODLY2X(min)}	Output hold time	DDR50	1.5	-	-	ns

SDIO Timing Data - DDR50 Mode (50MHz)

3.4.3 PCI Express Interface

3.4.3.1 Differential Tx Output Electricals

Symbol	Parameter	Min	Typ	Max	Units
UI	Unit interval Each UI is 400 ps \pm 300 PPM. UI does not account for SSC dictated variations.	399.98	400	400.12	ps
V_{Tx_DIFFpp}	Differential peak-to-peak output voltage $V_{Tx_DIFFpp} = 2 * V_{Tx_D+} - V_{Tx_D-} $	0.800	--	1.2	V
$V_{Tx_DE_RATIO}$	De-emphasized differential output voltage (ratio)	-3.0	-3.5	-4.0	db
T_{Rx_EYE}	Minimum Tx eye width	0.75	--	--	UI
$T_{Rx_EYE_MEDIAN_MAX_JIT}$	Maximum time between jitter median and maximum deviation from median	--	--	0.125	UI
T_{Tx_RISE} , T_{Tx_FALL}	D+/D- Tx output rise/fall time	0.125	--	--	UI
$V_{Tx_CM_DC_ACTIVE_IDLE_DELTA}$	Absolute delta of DC common mode voltage during L0 and electrical idle	0-	-	100	mV
$V_{Tx_CM_DC_LINE_DELTA}$	Absolute delta of DC common mode voltage between D+ and D-	0-	-	25	mV
$V_{Tx_IDLE_DIFFp}$	Electrical idle differential peak output voltage	0	--	20	mV
$V_{Tx_RCV_DETECT}$	Voltage change allowed during receiver detection	--	--	600	mV
$V_{Tx_DC_CM}$	Tx DC common mode voltage	--	--	3.6	V
I_{Tx_SHORT}	Tx short circuit current limit	--	--	90	mA
$T_{Tx_IDLE_MIN}$	Minimum time spent in electrical idle	50	--	--	UI
$T_{Tx_IDLE_SET_TO_IDLE}$	Maximum time to transition to a valid electrical idle after sending an electrical idle ordered set	--	--	20	UI
$T_{Tx_IDLE_TO_DIFF_DATA}$	Maximum time to transition to valid Tx specifications after leaving an electrical idle condition	--	--	20	UI
RL_{Tx_DIFF}	Differential return loss	10	--	--	dB
RL_{Tx_CM}	Common mode return loss	6	--	--	dB
C_{Tx}	AC coupling capacitor	75	--	200	nF
$T_{Crosstalk}$	Crosstalk random timeout	0	--	1	ms

3.4.3.2 Differential Rx Input Electricals

Symbol	Parameter	Min	Typ	Max	Units
UI	Unit interval Each UI is 400 ps \pm 300 ppm. UI does not account for SSC dictated variations.	399.98	400	400.12	ps
V _{Rx_DIFFpp}	Differential peak-to-peak voltage $V_{Rx_DIFFpp} = 2 * V_{Rx_D+} - V_{Rx_D-} $	0.175	--	1.2	V
T _{Rx_EYE}	Minimum receiver eye width	0.4	--	--	UI
T _{Rx_EYE_MEDIAN_MAX_JIT}	Maximum time between jitter median and maximum deviation from median	--	--	0.3	UI
V _{Rx_CM_ACp}	AC peak common mode input voltage	--	--	150	mV
RL _{Rx_DIFF}	Differential return loss	10	--	--	dB
RL _{Rx_CM}	Common mode return loss	6	--	--	dB
Z _{Rx_DIFF_DC}	DC differential input impedance	80	100	120	Ω
Z _{Rx_DC}	DC input impedance	40	50	60	Ω
Z _{Rx_HIGH_IMP_DC_POS}	Powered down DC input impedance positive	50	--	--	k
Z _{Rx_HIGH_IMP_DC_NEG}	Powered down DC input impedance negative	1	--	--	k Ω
V _{Rx_IDLE_DET_DIFFpp}	Electrical idle detect threshold	65	--	175	mV
T _{Rx_IDLE_DET_DIFF_ENTERTIME}	Unexpected electrical idle enter detect threshold integration time	--	--	10	ms
L _{Rx_SKEW}	Total skew	---	-2	0	ns

3.4.5.High-Speed UART Interface

The AW-XM458 supports a high-speed Universal Asynchronous Receiver/Transmitter (UART) interface, compliant to the industry standard 16550 specification. High-speed baud rates are supported to provide the physical transport between the device and the host for exchanging Bluetooth data.

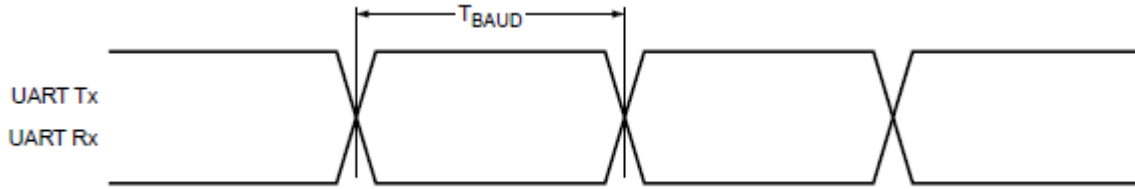

Symbol	Parameter	Condition	Min	Typ	Max	Units
T_{BAUD}	Baud rate	26MHz input clock	250	-	-	ns

3.4.6 PCM Interface

3.4.6.1 PCM Timing Specification – Master Mode

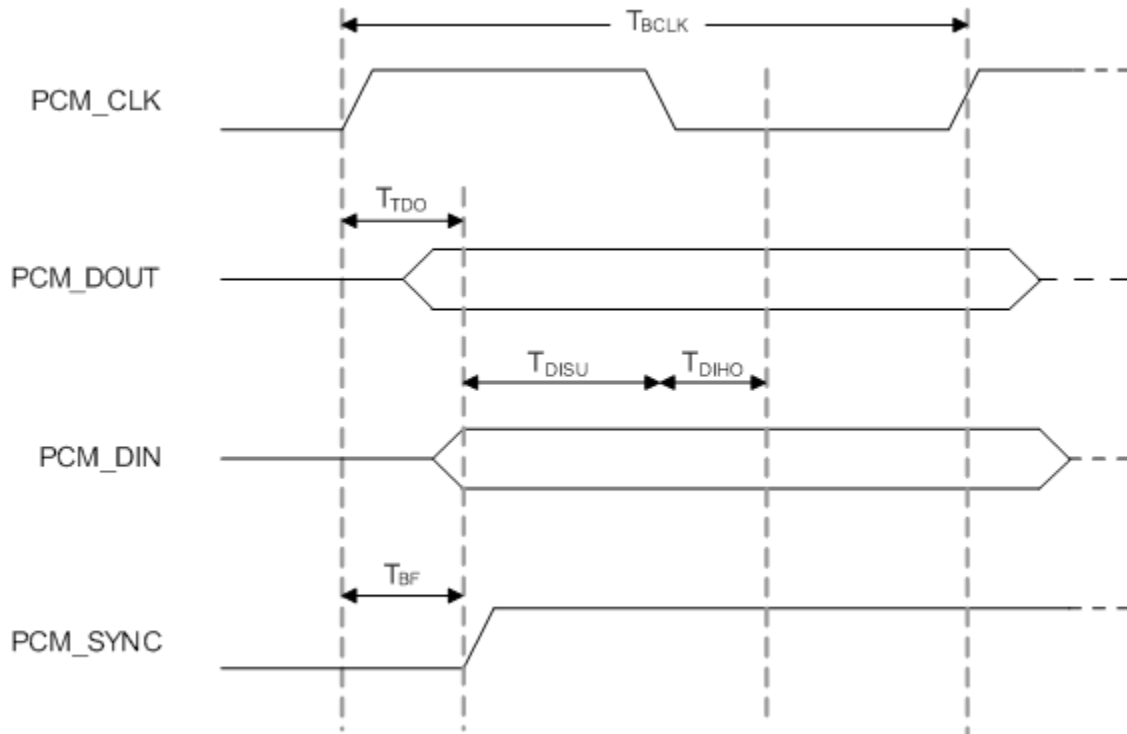

Symbol	Parameter	Condition	Min	Typ	Max	Units
F_{BCLK}	--	--	--	2/2.048	--	MHz
Duty Cycle $_{BCLK}$	--	--	0.4	0.5	0.6	--
T_{BCLK} rise/fall	--	--	--	3	--	ns
T_{DO}	--	--	--	--	15	ns
T_{DISU}	--	--	20	--	--	ns
T_{DIHO}	--	--	15	--	--	ns
T_{BF}	--	--	--	--	15	ns

3.4.6.2 PCM Timing Specification – Slave Mode

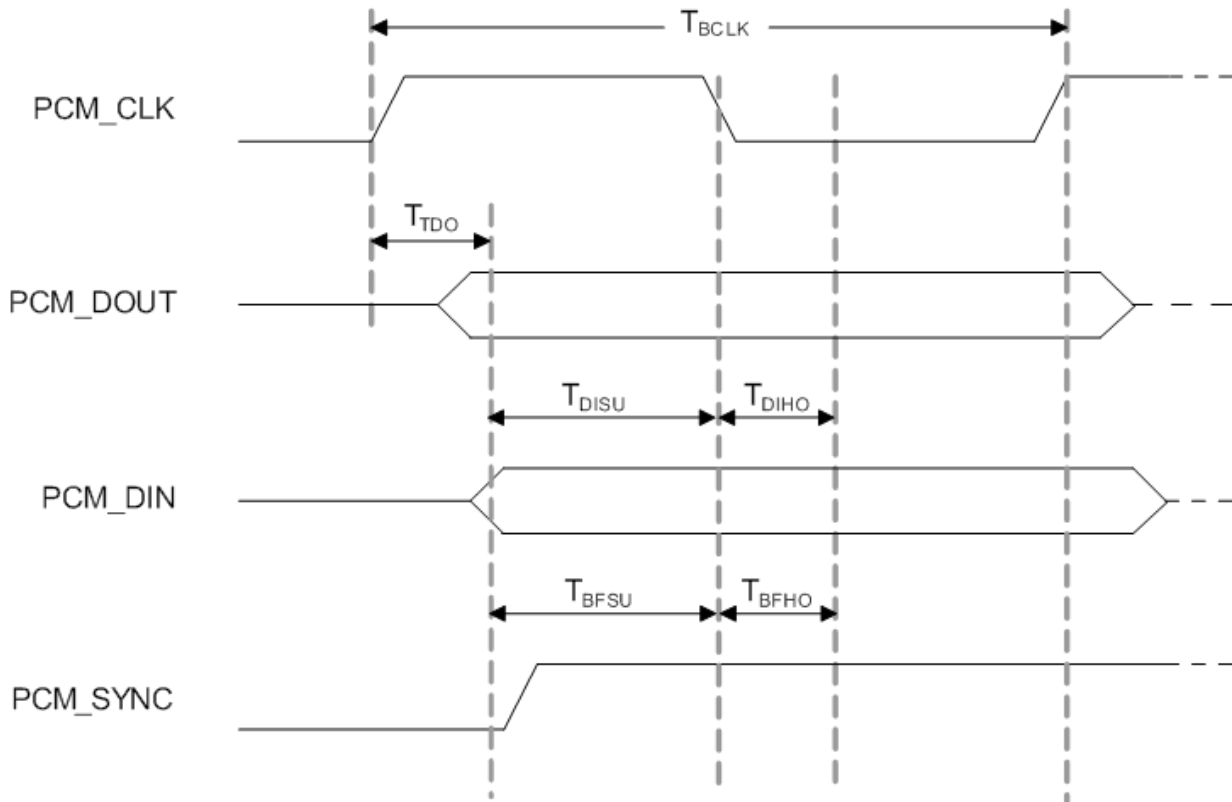

Symbol	Parameter	Condition	Min	Typ	Max	Units
F_{BCLK}	--	--	--	2/2.048	--	MHz
Duty Cycle $_{BCLK}$	--	--	0.4	0.5	0.6	--
T_{BCLK} rise/fall	--	--	--	3	--	ns
T_{DO}	--	--	--	--	30	ns
T_{DISU}	--	--	15	--	--	ns
T_{DIHO}	--	--	10	--	--	ns
T_{BFSU}	--	--	15	--	--	ns
T_{BFHO}	--	--	10	--	--	ns

3.5 Timing Sequence

AW-XM458 power up timing sequence.

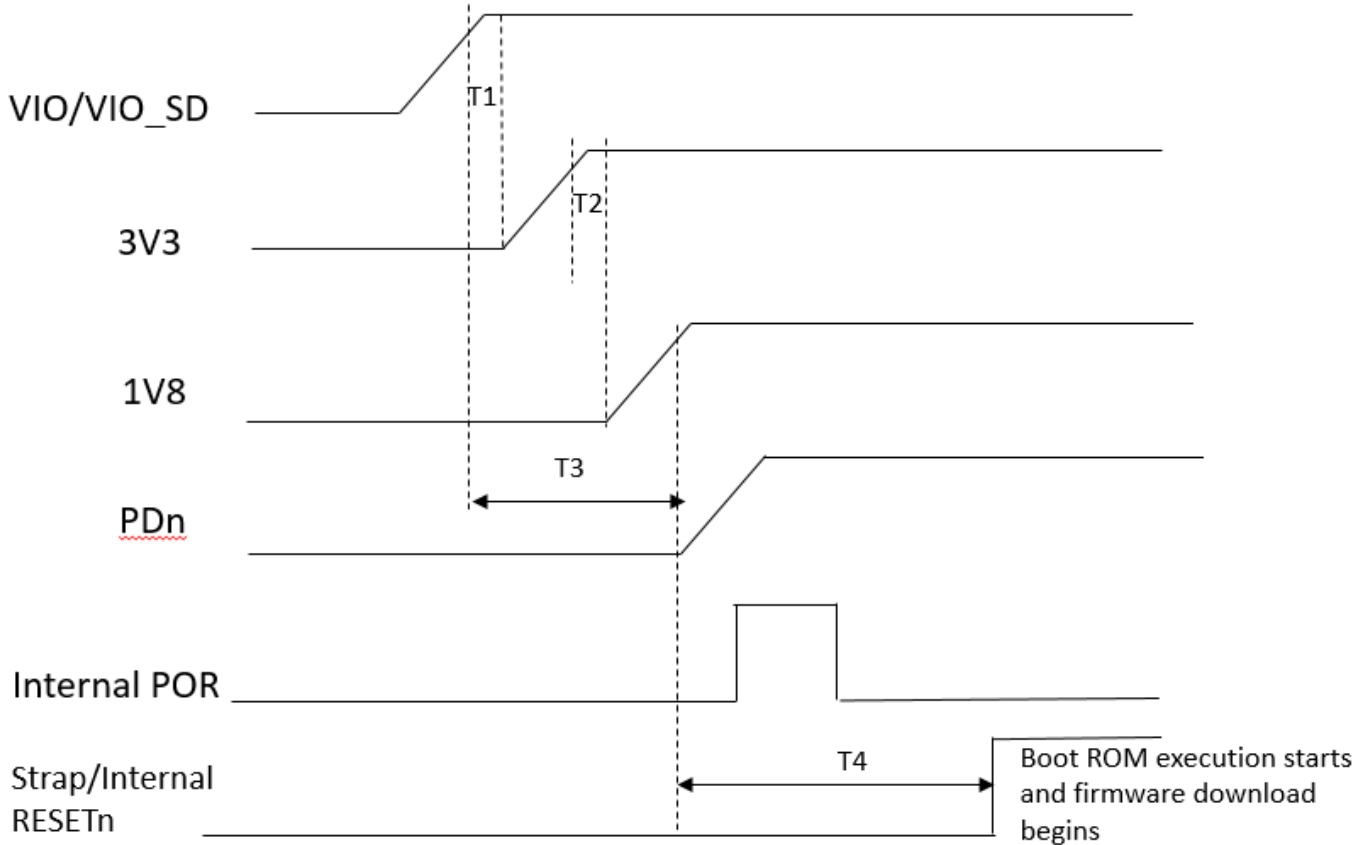

Symbol	Description	Min	Typ	Max	Units
T1	Delay from VIO/VIO_SD high (at least 90%) to start of VPA ramp-up	0	--	--	ms
T2	Delay from 3.3 high (at least 90%) to start of AVDD18 ramp-up	0	100	--	ms
T3	Delay from VIO/VIO_SD high (at least 90%) to start of PDn ramp-up	0	--	--	ms
T4	Delay from 1.8 high (90%) to start of Boot ROM	--	10	--	ms

3.6 Power Consumption*

3.6.1 WLAN

No.	Item			VDD=1.8V (mA)			VDD=3.3V (mA)		
				Max.	Avg.		Max.	Avg.	
1	Power down			0.018			0.276		
2	DeepSleep (Not associated with AP)			2.92	2.84		0.017	0.015	
3	Power Save (2.4GHz)			201	9.23		141	0.024	
4	Power Save (5GHz)			235	7.22		33.8	0.016	
Band (GHz)	Mode	BW (MHz)	RF Power (dBm)	Transmit					
				Max.	Avg.	Duty (%)	Max.	Avg.	Duty (%)
2.4	11b@1Mbps	20	18	271	271	100	181	181	99
	11g@6Mbps	20	17	295	293	100	171	170	99
	11n@MCS8 MIMO	40	16	400	399	92	322	320	94
	11n@MCS15 MIMO	40	16	384	384	71	282	281	77
	11ax@MCS11 NSS2	40	14	370	369	71	256	255	78
5	11a@6Mbps	20	16	365	365	99	203	203	98
	11n@MCS8 MIMO	40	16	517	516	92	395	395	94
	11n@MCS15 MIMO	40	16	518	498	71	349	348	78
	11ac@MCS0 NSS2	80	15	530	528	87	366	365	90
	11ac@MCS9 NSS2	80	15	502	501	65	315	315	73
	11ax@MCS0 NSS2	80	12	505	504	85	314	314	89
	11ax@MCS11 NSS2	80	12	484	484	70	284	284	77
Concurrent	11n@MCS0 MIMO(2.4G) +	40 +	16 +	749	745	87	640	637	87
	11ax@MCS0 NSS2(5G)	80	14						
	11ac@MCS0 NSS2 (5G) +	40 +	15 +	755	752	92	667	662	87
	11ax@MCS0 NSS2(2.4G)	40	16						
Band (GHz)	Mode	BW(MHz)	Receive						
			Max.	Avg.	Max.	Avg.			
2.4	11b@1Mbps	20	287	251	0.016	0.016			
	11ax@MCS0	40	320	314	N/T	N/T			
5	11a@6Mbps	20	354	351	0.016	0.016			
	11ax@MCS0 NSS1	80	387	380	N/T	N/T			

No.	Item			VIO=3.3V (uA)	
				Max.	Avg.
1	Power down			8.1	
2	DeepSleep (Not associated with AP)			81.8	81.4
3	Power Save (2.4GHz)			356	99.1
4	Power Save (5GHz)			356	95.2
Band (GHz)	Mode	BW (MHz)	RF Power (dBm)	Transmit	
				Max.	Avg.
2.4	11b@1Mbps	20	18	346	345
	11ax@MCS11 NSS2	40	14	353	352
5	11a@6Mbps	20	16	349	348
	11ax@MCS11 NSS2	80	12	357	355
Concurrent	11n@MCS0 MIMO(2.4G)	40	16	380	377
	+	+	+		
	11ax@MCS0 NSS2(5G)	80	14	384	382
	+	+	+		
11ac@MCS0 NSS2 (5G)	40	15			
	+	+	+		
	11ax@MCS0 NSS2(2.4G)	40	16		
Band (GHz)	Mode	BW(MHz)	Receive		
			Max.	Avg.	
2.4	11b@1Mbps	20	347	346	
5	11a@6Mbps	20	343	343	

3.6.2 Bluetooth

No.	Mode	RF Power (dBm)	VDD=1.8V(mA)		VDD=3.3V(uA)		VIO=3.3V(uA)	
			Max.	Avg.	Max.	Avg.	Max.	Avg.
1	Deepsleep	N/A	28.1	3.0	22.0	15.0	358	87.4
2	Transmit (DH5)	2	41.5	40.4	23.8	15.3	356	355
3	Receiver (3DH5)	N/A	46.5	39.8	23.4	15.1	356	355

4. Mechanical Information

4.1 Mechanical Drawing

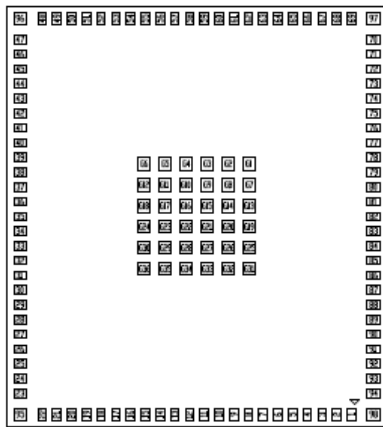

PIN DEFINED (BOTTOM VIEW)

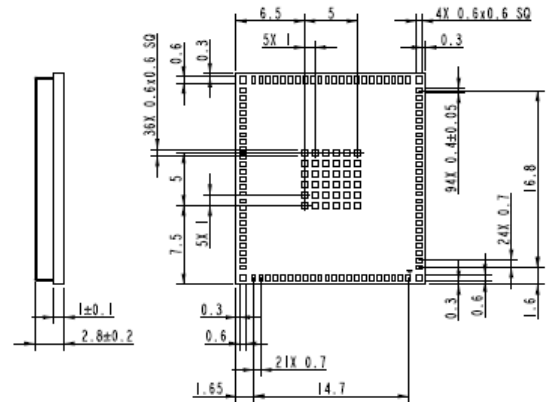
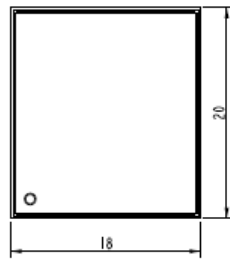
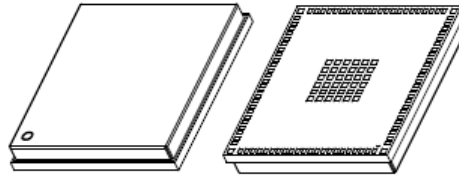

TOLERANCES UNLESS OTHERWISE SPECIFIED: ±0.1mm

5. Packing Information

1. One reel can pack 650pcs
2. One production label is pasted on the reel, one desiccant and one humidity indicator card are put on the reel

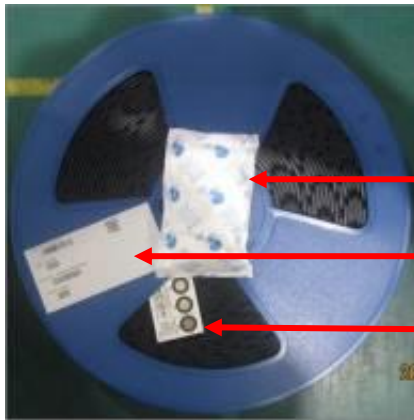

One desiccant

One production label

One humidity indicator card

3. One reel is put into the anti-static moisture barrier bag, and then one label is pasted on the bag



One production label

4. A bag is put into the anti-static pink bubble wrap

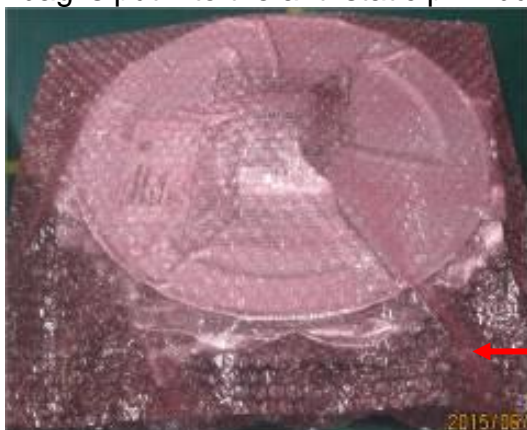

One anti-static pink bubble wrap

5. A bubble wrap is put into the inner box and then one label is pasted on the inner box



One production label

6. **4 inner boxes** could be put into one carton

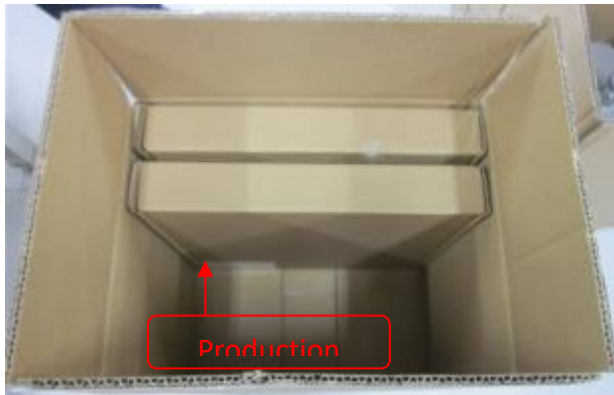







7. Sealing the carton by AzureWave tape



8. One carton label and one box label are pasted on the carton. If one carton is not full, one balance label pasted on the carton



<p>Example of carton label</p>	<table border="1"> <tr> <td colspan="2" style="text-align: center;">  </td> </tr> <tr> <td>AzureWave P/N</td> <td></td> </tr> <tr> <td>Customer</td> <td>由業務提供</td> </tr> <tr> <td>Customer P/N</td> <td>由業務提供</td> </tr> <tr> <td>Customer PO</td> <td>由業務提供</td> </tr> <tr> <td>Description</td> <td>AW-XXXXXX</td> </tr> <tr> <td>QTY</td> <td>1200 pcs</td> </tr> <tr> <td>C/N</td> <td></td> </tr> <tr> <td>N.W.</td> <td>G.W.</td> </tr> <tr> <td colspan="2" style="text-align: center;">  </td> </tr> </table>			AzureWave P/N		Customer	由業務提供	Customer P/N	由業務提供	Customer PO	由業務提供	Description	AW-XXXXXX	QTY	1200 pcs	C/N		N.W.	G.W.		
																					
AzureWave P/N																					
Customer	由業務提供																				
Customer P/N	由業務提供																				
Customer PO	由業務提供																				
Description	AW-XXXXXX																				
QTY	1200 pcs																				
C/N																					
N.W.	G.W.																				
																					
<p>Example of box label</p>																					



Example of production label	 <p>P/N:  D/C: 1309  PCK NO.: PCKNO0069097  QTY: 294  BAG SEAL DATE: _____</p>
Example of balance label	 <p>尾数 Balance</p>