

AW-XM458MA-SUR

**IEEE 802.11 2x2 Wi-Fi 6 SU and MU-MIMO
CDW Wireless LAN + Bluetooth 5.3
Combo M.2 2230 Module**

Datasheet

Rev. F

DF

For Standard

Features

WLAN

- ◆ Support 2x2 802.11 a/b/g/n/ac/ax
- ◆ Dual bands: 2.4 GHz and 5 GHz
- ◆ Support 20/40/80 MHz channel Bandwidths.
- ◆ 5GHz PHY data rates up to 1.2 Gbps
- ◆ 2.4 GHz PHY data rates up to 458 Mbps
- ◆ Uplink and downlink OFDMA and MU-MIMO
- ◆ Instantaneous 0-DFS

WLAN Dual-Radios

- ◆ Dual, independent direct-conversion WLAN radios (with dual-MACs and dual-Basebands) supports true and simultaneous LAN network operation at two different frequency band

Bluetooth

- ◆ Bluetooth 5.3
- ◆ Bluetooth class 2
- ◆ Bluetooth class 1
- ◆ PCM interface for voice applications
- ◆ 2Mbit/s LE
- ◆ Long range
- ◆ LTE/MWS coexistence
- ◆ 2 x wide band speech (WBS) calls
- ◆ Security: AES

Revision History

Document NO: R2-2458MA-DST-02

Version	Revision Date	DCN NO.	Description	Initials	Approved
A	2020/07/21	DCN019506	<ul style="list-style-type: none"> ● Draft version 	Renton Tao	N.C Chen
B	2021/11/10	DCN024103	<ul style="list-style-type: none"> ● Correct pin definition table ● Modify table format ● Modify pin table ● Add the information of RF connector receptacle ● Update RF specification ● Update BLE 1M spec 	Roger Liu	N.C Chen
C	2021/11/30	DCN024481	<ul style="list-style-type: none"> ● Modify Pin Table 	Roger Liu	N.C Chen
D	2022/11/29	DCN028155	<ul style="list-style-type: none"> ● Update pin table pin54 voltage 	Roger Liu	N.C Chen
E	2023/9/13	DCN030053	<ul style="list-style-type: none"> ● Modify Wi-Fi 2.4G RF spec. 	Roger Liu	N.C Chen
F	2023/10/12	DCN030245	<ul style="list-style-type: none"> ● Modify Wi-Fi 2.4G RF spec. 	Roger Liu	N.C Chen

Table of Contents

Revision History.....	3
Table of Contents.....	4
1. Introduction	5
1.1 Product Overview	5
1.2 Block Diagram.....	6
1.3 Specifications Table	7
1.3.1 General	7
1.3.2 WLAN	7
1.3.3 Bluetooth.....	9
1.3.4 Operating Conditions.....	10
2.1 Pin Table.....	11
3. Electrical Characteristics	13
3.1 Absolute Maximum Ratings	13
3.2 Recommended Operating Conditions	13
3.3 Digital IO Pin DC Characteristics.....	13
3.3.1 1.8V Operation (VIO).....	13
3.3.2 1.8V Operation (VIO_SD).....	14
3.4 Host Interface.....	15
3.4.1 SDIO Interface	15
3.4.2.High-Speed UART Interface.....	21
3.5 Timing Sequence	22
3.6 Power Consumption*.....	23
3.6.1 WLAN	23
3.6.2 Bluetooth.....	23
4. Mechanical Information	24
4.1 Mechanical Drawing	24
5. Packing Information.....	25

1. Introduction

1.1 Product Overview

AzureWave Technologies, Inc. introduces the IEEE 802.11a/b/g/n/ac/ax Concurrent Dual Wi-Fi (CDW) and BT, combo module – **AW-XM458MA-SUR**. With High Efficiency Wireless (HEW) and backward compatible with 802.11ac technologies integrated into a module, AW-XM458MA-SUR provides the best and most convenient SMT process. The module is targeted to mobile devices including, Tablet PC, Portable Media Players (PMPs), Portable Navigation Devices (PNDs), Personal Digital Assistants (PDAs), Tracking Devices, Gaming Devices which need convenient SMT process, low power consumption.

By using AW-XM458MA-SUR, the customers can easily integrate the Wi-Fi, BT, by a combo module with the benefits of **high design flexibility, high success rate on SMT process, short development cycle, and quick time-to-market.**

Compliance with the IEEE 802.11a/b/g/n/ac/ax standard, the AW-XM458MA-SUR uses **DSSS, OFDM, DBPSK, DQPSK, CCK** and **QAM** baseband modulation technologies. A high level of integration and full implementation of the power management functions specified in the IEEE 802.11 standard minimize the system power requirements by using AW-XM458MA-SUR.

The AW-XM458MA-SUR supports standard interface **SDIO for WLAN** interface connection. High-Speed **UART for BT** interface connection. AW-XM458MA-SUR is suitable for multiple mobile processors for different applications. With the combo functions and the good performance, the AW-XM458MA-SUR is the best solution for the consumer electronics and the tablet PC.

Scenario	2.4GHz Band			5GHz Band		
	Mode	Technology	BW	Mode	Technology	BW
1	2x2	802.11n	40MHz	2x2	802.11ax	80MHz
2	2x2	802.11n	40MHz	1x1 1Rx	802.11ax Zero Wait DFS	80MHz 80MHz
3	2x2	802.11ax	40MHz	2x2	802.11ac	40MHz

Concurrent 2.4GHz and 5GHz modes supported table

1.2 Block Diagram

A simplified block diagram of the AW-XM458MA-SUR module is depicted in the figure below.

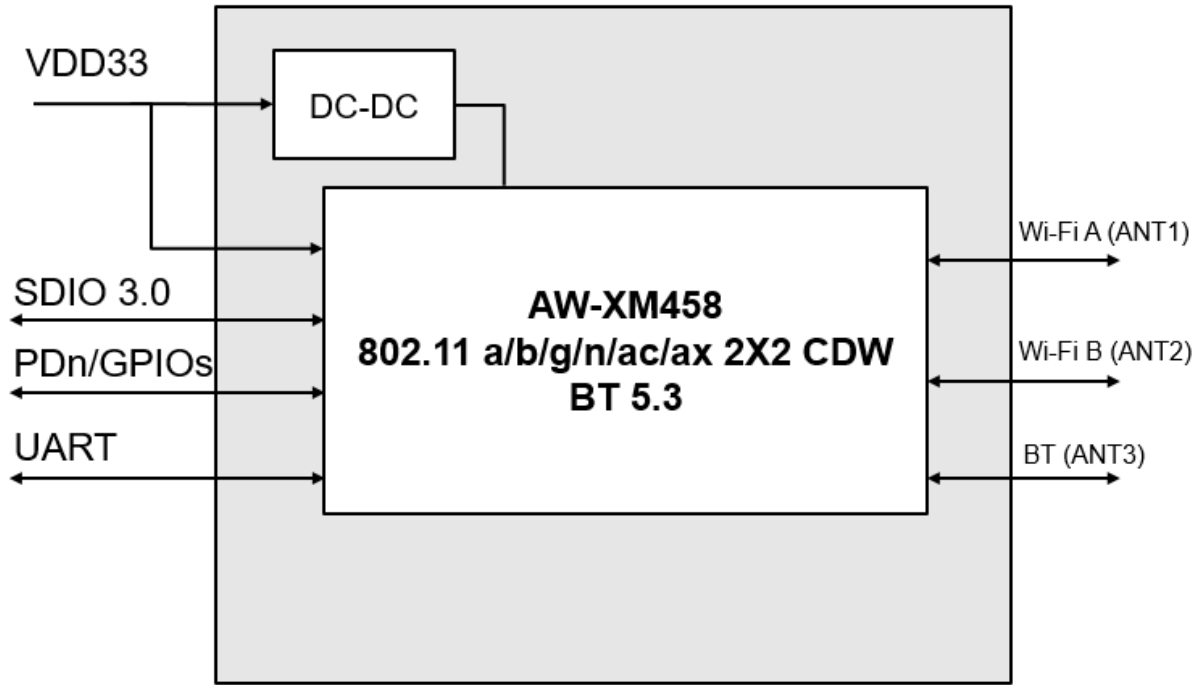

AW-XM458MA-SUR Block Diagram

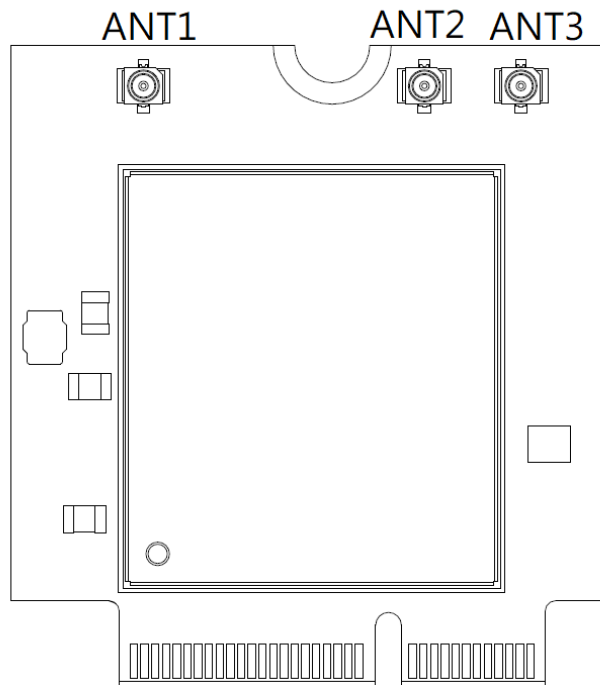

1.3 Specifications Table

1.3.1 General

Features	Description
Product Description	IEEE 802.11 2X2 WiFi 6 MIMO Wireless LAN + Bluetooth 5.3 Combo LGA Module
Major Chipset	NXP 88W9098 (DR-QFN 148pin)
Host Interface	Wi-Fi + BT ● SDIO3.0 + UART
Dimension	28 mm x 30 mm x 3.95 mm(Max) (Tolerance remarked in mechanical drawing)
Form factor	Alternative sized M.2 2230 Key E
Antenna	2T2R for Wi-Fi, standalone antenna for BT IPEX MHF4 connector Receptacle (20449) ANT1(Main) : Wi-Fi_A → TX/RX ANT2(Aux) : Wi-Fi_B → TX/RX ANT3(BT): BT
Weight	0.004 kg

1.3.2 WLAN

Features	Description
WLAN Standard	IEEE 802.11 a/b/g/n/ac/ax 2T2R
Frequency Range	2.4 GHz ISM Bands 2.412-2.472 GHz 5.15-5.25 GHz (FCC UNII-low band) for US/Canada and Europe 5.25-5.35 GHz (FCC UNII-middle band) for US/Canada and Europe 5.47-5.725 GHz for Europe 5.725-5.825 GHz (FCC UNII-high band) for US/Canada
Modulation	DSSS, OFDM, DBPSK, DQPSK, CCK, 16-QAM, 64-QAM, 256QAM, 1024QAM, OFDMA
Number of Channels	2.4GHz: <ul style="list-style-type: none"> ■ USA, NORTH AMERICA, Canada and Taiwan - 1 ~ 11 ■ China, Australia, Most European Countries - 1 ~ 13 ■ Japan, 1 ~ 13 5GHz: <ul style="list-style-type: none"> ■ USA, Canada, Most European Countries - 36,40,44,48,52,56,60,64,100,104,108,112,116,120,124,128,132,136,140,149,153,157,161,165 ■ Japan -

	36,40,44,48,52,56,60,64,100,104,108,112,116,120,124,128,132,136,140 ■ China - 36,40,44,48,52,56,60,64, 149,153,157,161,165				
Output Power	2.4G				
		Min	Typ	Max	Unit
	11b (11Mbps) @EVM<35%	16	18	20	dBm
	11g (54Mbps) @EVM≤-27 dB	15.5	17	18.5	dBm
	11n (HT20 MCS7) @EVM≤-28 dB	14.5	16	17.5	dBm
	11ax (HE20 MCS11) @EVM≤-35 dB	12.5	14	15.5	dBm
	5G				
		Min	Typ	Max	Unit
	11a (54Mbps) @EVM≤-27 dB	14	16	18	dBm
	11n (HT20 MCS7) @EVM≤-28 dB	14	16	18	dBm
	11n (HT40 MCS7) @EVM≤-28 dB	14	16	18	dBm
	11ac(VHT20 MCS8) @EVM≤-31 dB	13	15	17	dBm
	11ac(VHT40 MCS9) @EVM≤-32 dB	13	15	17	dBm
	11ac(VHT80 MCS9) @EVM≤-32 dB	13	15	17	dBm
	11ax(HE20 MCS11) @EVM≤-35 dB	10	12	14	dBm
	11ax(HE40 MCS11) @EVM≤-35 dB	10	12	14	dBm
	11ax(HE80 MCS11) @EVM≤-35 dB	10	12	14	dBm
	Receiver Sensitivity	2.4G			
		Min	Typ	Max	Unit
11b (11Mbps)		-	-88	-85	dBm
11g (54Mbps)		-	-75	-72	dBm
11n (HT20 MCS7)		-	-72	-69	dBm
11ax(HE20 MCS11)		-	-62	-58	dBm
5G					
		Min	Typ	Max	Unit
11a (54Mbps)		-	-72	-68	dBm
11n (HT20 MCS7)		-	-70	-66	dBm

	11n (HT40 MCS7)	-	-68	-64	dBm
	11ac(VHT20 MCS8)	-	-65	-61	dBm
	11ac(VHT40 MCS9)	-	-62	-58	dBm
	11ac(VHT80 MCS9)	-	-59	-55	dBm
	11ax(HE20 MCS11)	-	-60	-56	dBm
	11ax(HE40 MCS11)	-	-57	-53	dBm
	11ax(HE80 MCS11)	-	-55	-51	dBm
Data Rate	<ul style="list-style-type: none"> ■ 802.11b: 1, 2, 5.5, 11Mbps ■ 802.11a/g: 6, 9, 12, 18, 24, 36, 48, 54Mbps ■ 802.11n: up to 150Mbps-single ■ 802.11n: up to 300Mbps-2x2 MIMO ■ 802.11ac:up to 192.6Mbps (20MHz channel) ■ 802.11ac:up to 400Mbps (40MHz channel) ■ 802.11ac:up to 866.7Mbps (80MHz channel) ■ 802.11ax:2.4GHz up to 458Mbps, 5GHz up to 1.2Gbps 				
Security	Wi-Fi: WPA/WPA2/WPA3				

* If you have any certification questions about output power please contact FAE directly.

1.3.3 Bluetooth

Features	Description				
Bluetooth Standard	Bluetooth 5.3				
Bluetooth VID/PID	N/A				
Frequency Range	2402MHz~2483MHz				
Modulation	Header GFSK Payload 2M: $\pi/4$ -DQPSK Payload 3M: 8DPSK				
Output Power		Min	Typ	Max	Unit
	BDR	0	2	4	dBm
	EDR	0	2	4	dBm
	Low Energy (1MHz)	0	2	4	dBm
	Low Energy (2MHz)	0	2	4	dBm
Receiver Sensitivity		Min	Typ	Max	Unit
	BDR	-	-90	-87	dBm
	EDR	-	-87	-84	dBm
	Low Energy (1MHz)	-	-86	-83	dBm
	Low Energy (2MHz)	-	-85	-82	dBm

--	--

1.3.4 Operating Conditions

Features	Description
Operating Conditions	
Voltage	3.3V+-5%
Operating Temperature	-40°C~ 85°C
Operating Humidity	less than 85% R.H.
Storage Temperature	-40°C~ 85°C
Storage Humidity	less than 60% R.H.

2.1 Pin Table

Pin No.	Definition	Basic Description	Voltage	Type
1	GND	Ground.		GND
2	VDD33	3.3V power supply	3.3V	VCC
3	NC	NC		Floating
4	VDD33	3.3V power supply	3.3V	VCC
5	NC	NC		Floating
6	NC	NC		Floating
7	GND	Ground.		GND
8	PCM_CLK	PCM_CLK, GPIO Mode : GPIO[6].	1.8V	I/O
9	SD_CLK	SDIO Clock input	1.8V	Input
10	PCM_SYNC	PCM_SYNC, GPIO Mode : GPIO[7].	1.8V	I/O
11	SD_CMD	SDIO Command/response (input/output)	1.8V	I/O
12	PCM_OUT	PCM_OUT, GPIO Mode : GPIO[5].	1.8V	I/O
13	SD_DAT[0]	SDIO Data line Bit[0]	1.8V	I/O
14	PCM_DIN	PCM_DIN, GPIO Mode : GPIO[4].	1.8V	I/O
15	SD_DAT[1]	SDIO Data line Bit[1]	1.8V	I/O
16	NC	NC		Floating
17	SD_DAT[2]	SDIO Data line Bit[2]	1.8V	I/O
18	GND	Ground.		GND
19	SD_DAT[3]	SDIO Data line Bit[3]	1.8V	I/O
20	UART WAKE#	BT WAKE HOST, GPIO Mode : GPIO[16].	3.3V	Output
21	SDIO WAKE#	WLAN WAKE HOST, GPIO Mode : GPIO[15]	1.8V	Output
22	UART_TX	UART SOUT pin	1.8V	Output
23	SDIO RESET#	WLAN independent reset, GPIO Mode : GPIO[18]	1.8V	Input
32	UART_RX	UART SIN.pin	1.8V	Input
33	GND	Ground.		GND
34	UART_RTSn	UART Mode: UART_RTSn (active low)	1.8V	Output
35	NC	NC		Floating
36	UART_CTSn	UART Mode: UART_CTSn (active low)	1.8V	Input
37	NC	NC		Floating
38	JTAG_TDO	JTAG_TDO, GPIO Mode :GPIO[31]	1.8V	Output
39	GND	Ground.		GND
40	WLAN WAKE	DEV WLAN WAKE, GPIO Mode :GPIO[12]	1.8V	Input
41	NC	NC		Floating
42	BT WAKE	DEV BT WAKE, GPIO Mode :GPIO[1]	1.8V	Input
43	NC	NC		Floating
44	JTAG_TDI	JTAG_TDI, GPIO Mode :GPIO[30]	1.8V	Input
45	GND	Ground.		GND
46	JTAG_TCK	JTAG_TCK, GPIO Mode :GPIO[28]	1.8V	I/O
47	NC	NC		Floating

48	JTAG_TMS	JTAG_TMS, GPIO Mode :GPIO[29]	1.8V	I/O
49	NC	NC		Floating
50	NC	NC		Floating
51	GND	Ground.		GND
52	NC	NC		Floating
53	NC	NC		Floating
54	W_DISABLE2_N	BT_INDEPENDENT_RESET	3.3V	I/O
55	NC	NC		Floating
56	W_DISABLE1#	Pull power down for WLAN/BT	3.3V	IN
57	GND	Ground.		GND
58	NC	NC		Floating
59	NC	NC		Floating
60	NC	NC		Floating
61	NC	NC		Floating
62	NC	NC		Floating
63	GND	Ground.		GND
64	NC	NC		Floating
65	NC	NC		Floating
66	NC	NC		Floating
67	NC	NC		Floating
68	NC	NC		Floating
69	GND	Ground.		GND
70	NC	NC		Floating
71	NC	NC		Floating
72	VDD33	3.3V power supply	3.3V	VCC
73	NC	NC		Floating
74	VDD33	3.3V power supply	3.3V	VCC
75	GND	Ground.		GND
76	GND	Ground.		GND

3. Electrical Characteristics

3.1 Absolute Maximum Ratings

Symbol	Parameter	Minimum	Typical	Maximum	Unit
3V3	DC supply for the 3.3V input	-	3.3	3.63	V

3.2 Recommended Operating Conditions

Symbol	Parameter	Minimum	Typical	Maximum	Unit
3.3V	DC supply for the 3.3V input	3.14	3.3	3.46	V

3.3 Digital IO Pin DC Characteristics

3.3.1 1.8V Operation (VIO)

Symbol	Parameter	Minimum	Typical	Maximum	Unit
V _{IH}	Input high voltage	0.7*VIO	-	VIO+0.4	V
V _{IL}	Input low voltage	-0.4	-	0.3*VIO	
V _{OH}	Output high voltage	VIO-0.4	-	-	
V _{OL}	Output low voltage	-	-	0.4	
V _{HYS}	Input Hysteresis	100			mV

3.3.2 1.8V Operation (VIO_SD)

Symbol	Parameter	Minimum	Typical	Maximum	Unit
V _{IH}	Input high voltage	0.7*VIO_SD	-	VIO_SD+0.4	V
V _{IL}	Input low voltage	-0.4	-	0.3*VIO_SD	
V _{OH}	Output High Voltage	VIO_SD-0.4	-	-	
V _{OL}	Output Low Voltage	-	-	0.4	
V _{HYS}	Input Hysteresis	100			mV

3.4 Host Interface

3.4.1 SDIO Interface

The AW-XM458MA-SUR supports a SDIO device interface that conforms to the industry SDIO Full-Speed card specification and allows a host controller using the SDIO bus protocol to access the Wireless SoC device.

The AW-XM458MA-SUR acts as the device on the SDIO bus. The host unit can access registers of the SDIO interface directly and can access shared memory in the device through the use of BARs and a DMA engine.

- ◆ Support SDIO 3.0 Standard.
- ◆ On-chip memory used for CIS.
- ◆ Supports 4-bit SDIO and 1-bit SDIO transfer modes.
- ◆ Special interrupt register for information exchange.
- ◆ Allows card to interrupt host.

SDIO Interface Signals

AW-XM458MA-SUR SDIO Pin Name	Type	Description
SDIO_DATA_CLK	I	SDIO 4-bit mode: Clock SDIO 1-bit mode: Clock
SDIO_DATA_CMD	I/O	SDIO 4-bit mode: Command line SDIO 1-bit mode: Command line
SDIO_DATA_3	I/O	SDIO 4-bit mode: Data line Bit[3] SDIO 1-bit mode: Not used
SDIO_DATA_2	I/O	SDIO 4-bit mode: Data line Bit[2] or Read Wait (optional) SDIO 1-bit mode: Read Wait (optional)
SDIO_DATA_1	I/O	SDIO 4-bit mode: Data line Bit[1] SDIO 1-bit mode: Interrupt
SDIO_DATA_0	I/O	SDIO 4-bit mode: Data line Bit[0] SDIO 1-bit mode: Data line

3.4.2 SDIO Protocol Timing

3.4.2.1 Default Speed, High-Speed Modes (3.3V)

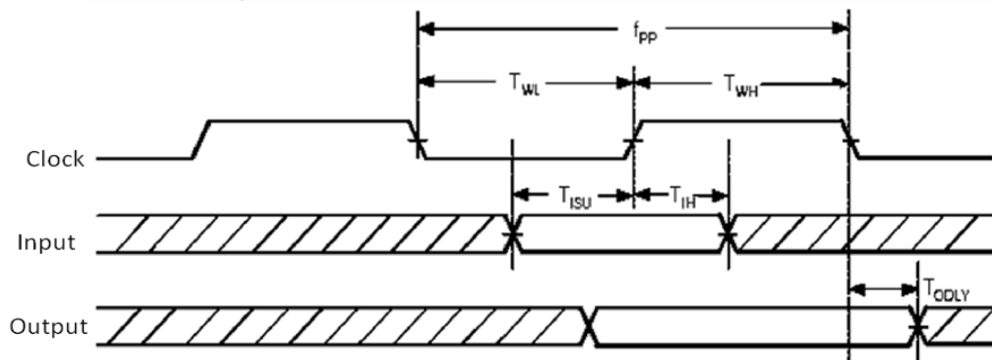

SDIO protocol timing Diagram - Default mode. (3.3V)

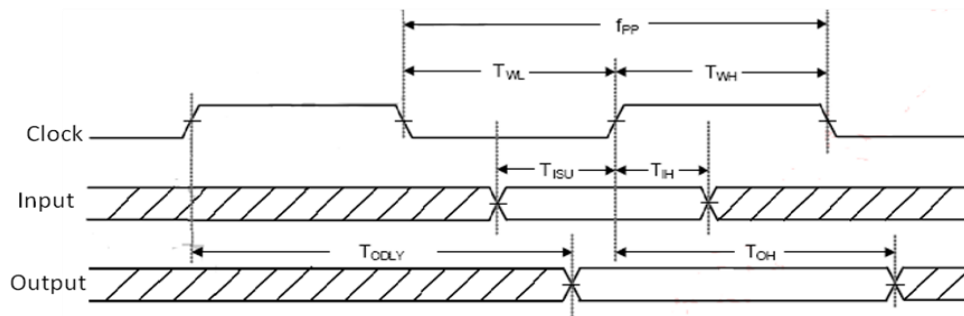

SDIO protocol timing Diagram - High Speed mode. (3.3V)

Symbol	Parameter	Condition	Min	Typ	Max	Units
f _{pp}	CLK Frequency	Normal	0	--	25	MHz
		High Speed	0	--	50	MHz
T _{WH}	CLK High Time	Normal	10	--	--	ns
		High Speed	7	--	--	ns
T _{WL}	CLK Low Time	Normal	10	--	--	ns
		High Speed	7	--	--	ns
T _{ISU}	Input Setup Time	Normal	5	--	--	ns
		High Speed	6	--	--	ns
T _{IH}	Input Hold Time	Normal	5	--	--	ns
		High Speed	2	--	--	ns
T _{ODLY}	Output Delay Time	Normal	--	--	14	ns
	CL ≤ 40pF (1 card)	High Speed	--	--	14	ns
T _{OH}	Output Hold Time	High Speed	2.5	--	--	ns

SDIO Timing Data – Default Speed / High-Speed modes. (3.3V)

3.4.2.2 SDR12, SDR25, SDR50 Modes (up to 100MHz) (1.8V)

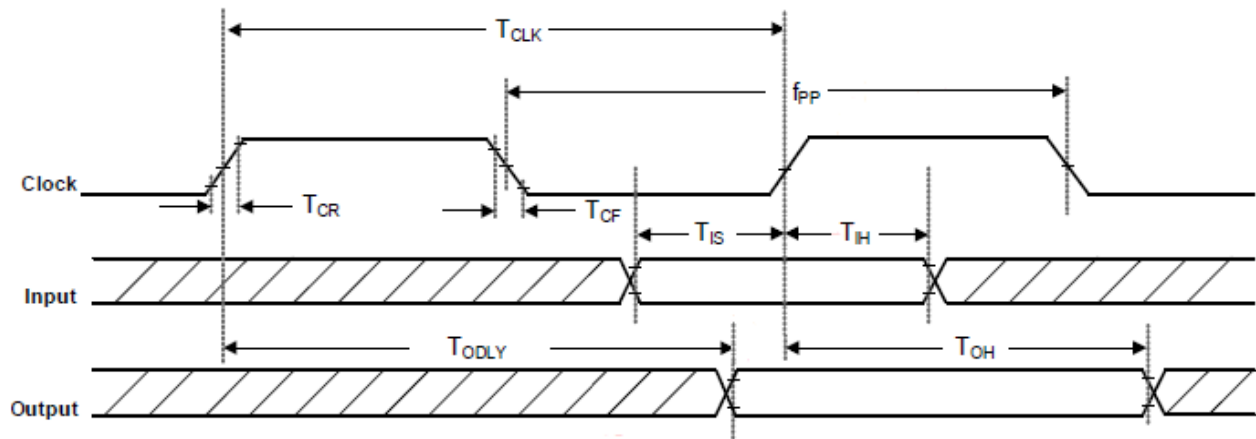

SDIO Protocol Timing Diagram - SDR12, SDR25, SDR50 Modes (up to 100 MHz)(1.8V)

Symbol	Parameter	Condition	Min	Typ	Max	Units
F_{pp}	CLK Frequency	SDR12/25/50	25	-	100	MHz
T_{CLK}	Clock Time	SDR12/25/50	10	-	40	ns
T_{IS}	Input Setup Time	SDR12/25/50	3	-	-	ns
T_{IH}	Input Hold Time	SDR12/25/50	0.8	-	-	ns
T_{CR}, T_{CF}	Rise time, fall time TCR, TCF < 2ns(max) at 100MHz CCARD = 10pF	SDR12/25/50	-	-	$0.2 * T_{CLK}$	ns
T_{ODLY}	Output Delay Time CL ≤ 30pF	SDR12/25/50	-	-	7.5	ns
T_{OH}	Output Hold Time CL = 15pF	SDR12/25/50	1.5	-	-	ns

SDIO Timing Data - SDR12/25/50 modes. (1.8V)

3.4.2.3 SDR104 Mode (208MHz) (1.8V)

SDIO Protocol Timing Diagram –SDR104 Mode (208MHz)

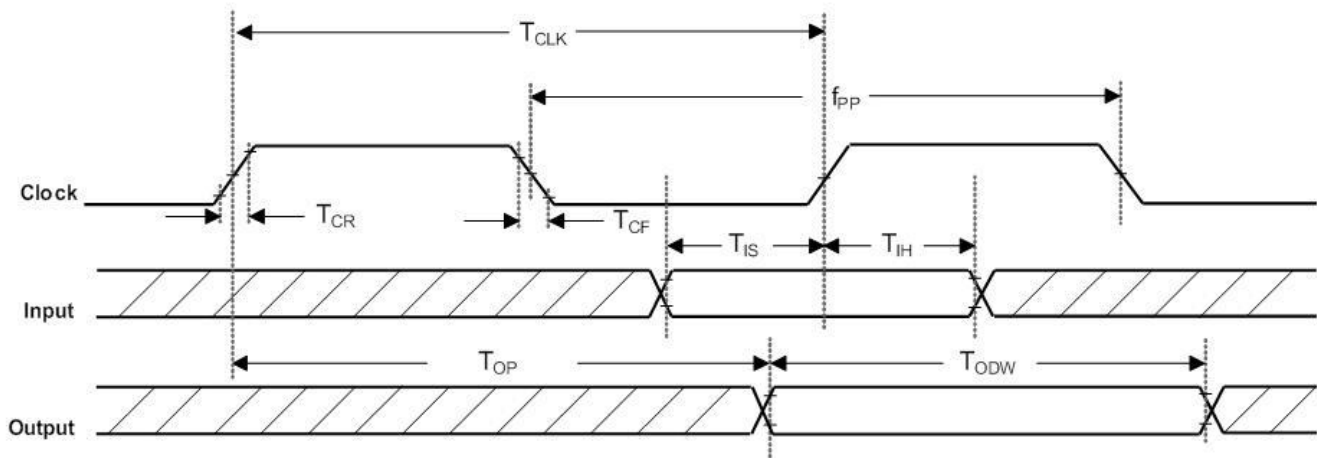
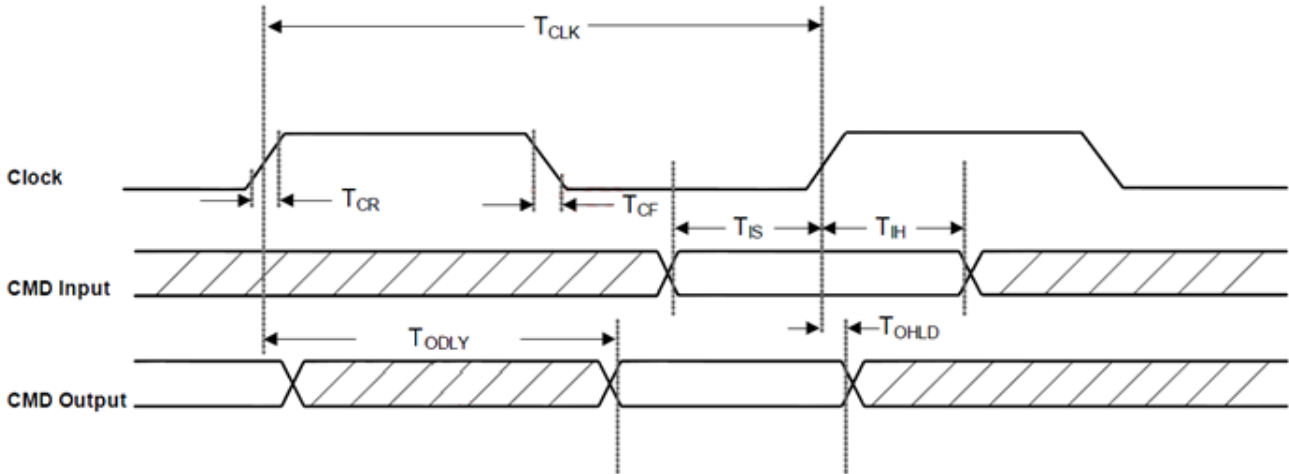

Table shows SDIO Timing Data—SDR104 Mode (208MHz)

Symbol	Parameter	Condition	Min	Typ	Max	Units
f_{pp}	CLK Frequency	SDR104	0	-	208	MHz
T_{CLK}	Clock Time	SDR104	4.8	-	-	ns
T_{IS}	Input Setup Time	SDR104	1.4	-	-	ns
T_{IH}	Input Hold Time	SDR104	0.8	-	-	ns
T_{CR}, T_{CF}	Rise time, fall time $T_{CR}, T_{CF} < 0.96\text{ns}(\text{max})$ at 208MHz $C_{CARD}=10\text{pF}$	SDR104	-	-	$0.2 \cdot T_{CLK}$	ns
T_{OP}	Card output phase	SDR104	0	-	10	ns
T_{ODW}	Output timing of variable data window	SDR104	2.88	-	-	ns

3.4.2.4 DDR50 Mode (50MHz) (1.8V)



SDIO CMD Timing Diagram - DDR50 Mode (50 MHz)

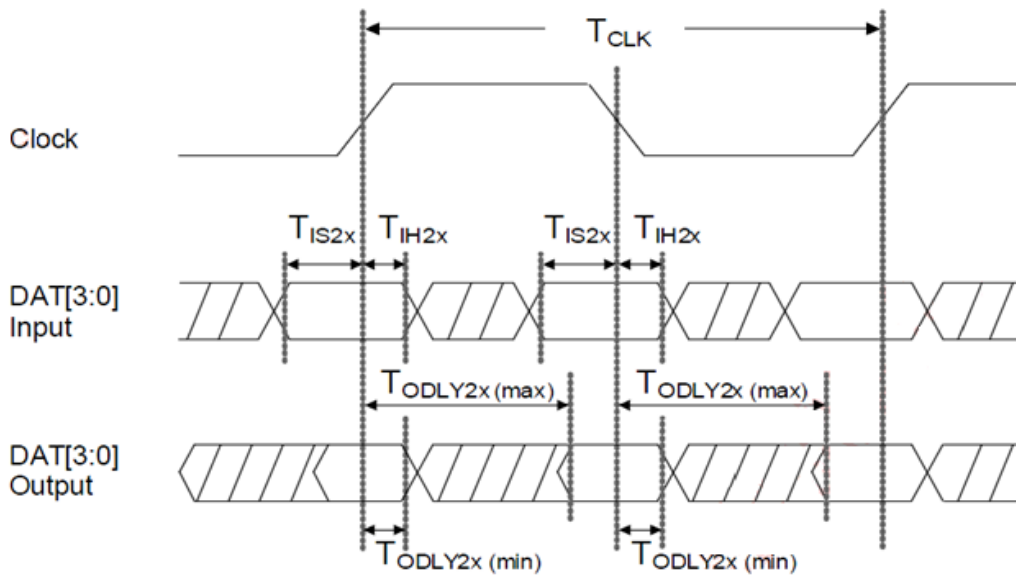

SDIO DAT[3:0] Timing Diagram - DDR50 Mode¹ (50 MHz)

¹ In DDR50 mode, DAT[3:0] lines are sampled on both edges of the clock (not applicable for CMD line).

Symbol	Parameter	Condition	Min	Typ	Max	Units
Clock						
T _{CLK}	Clock time	DDR50	20	-	-	ns
T _{CR} , T _{CF}	Rise time, fall time	DDR50	-	-	0.2*T _{CLK}	Ns
Clock Duty		DDR50	45	-	55	%
CMD Input						
T _{IS}	Input setup time	DDR50	6	-	-	ns
T _{IH}	Input hold time	DDR50	0.8	-	-	ns
CMD Output						
T _{ODLY}	Output delay time during data transfer mode	DDR50	-	-	13.7	ns
T _{OHLd}	Output hold time	DDR50	1.5	-	-	ns
DAT [3:0] Input						
T _{IS2X}	Input setup time	DDR50	3	-	-	ns
T _{IH2X}	Input hold time	DDR50	0.8	-	-	ns
DAT [3:0] Output						
T _{ODLY2X(max)}	Output delay time during data transfer mode	DDR50	-	-	7	ns
T _{ODLY2X(min)}	Output hold time	DDR50	1.5	-	-	ns

SDIO Timing Data - DDR50 Mode (50MHz)

3.4.2.High-Speed UART Interface

The AW-XM458MA-SUR supports a high-speed Universal Asynchronous Receiver/Transmitter (UART) interface, compliant to the industry standard 16550 specification. High-speed baud rates are supported to provide the physical transport between the device and the host for exchanging Bluetooth data.

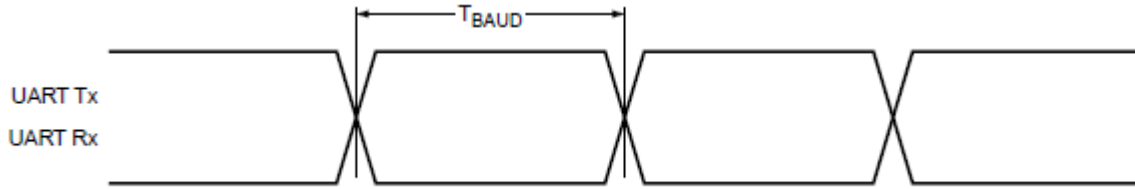

Symbol	Parameter	Condition	Min	Typ	Max	Units
T_{BAUD}	Baud rate	26MHz input clock	250	-	-	ns

3.5 Timing Sequence

AW-XM458MA-SUR power up timing sequence.

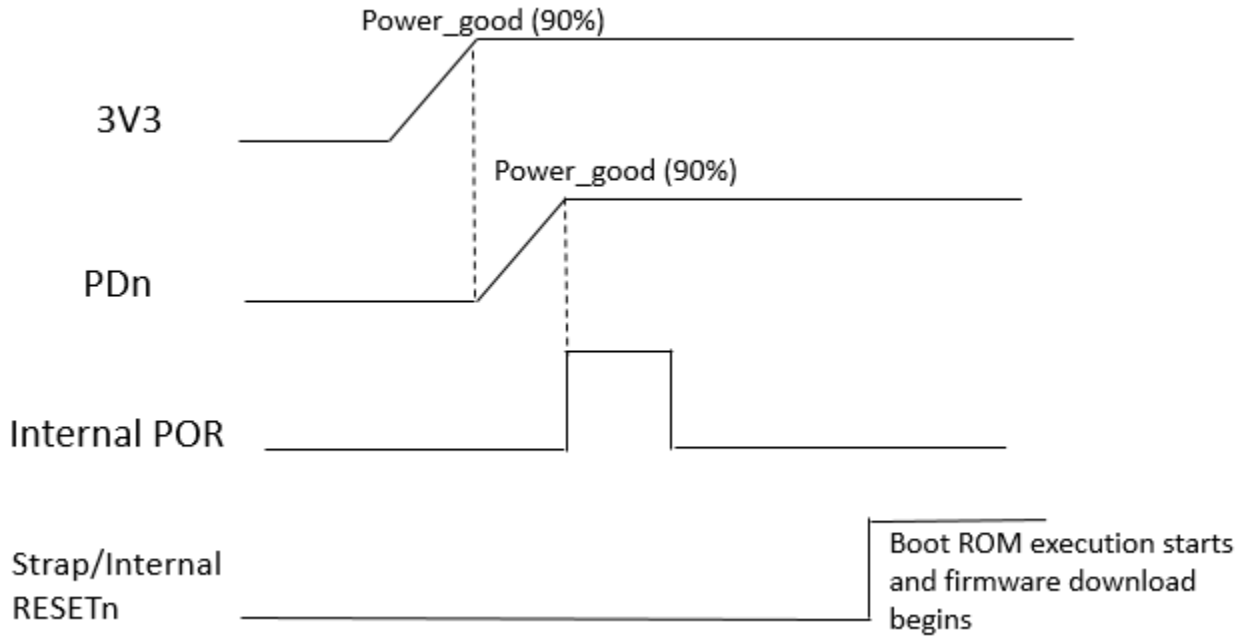

3.6 Power Consumption*

3.6.1 WLAN

3.6.2 Bluetooth

TBD

4. Mechanical Information

4.1 Mechanical Drawing

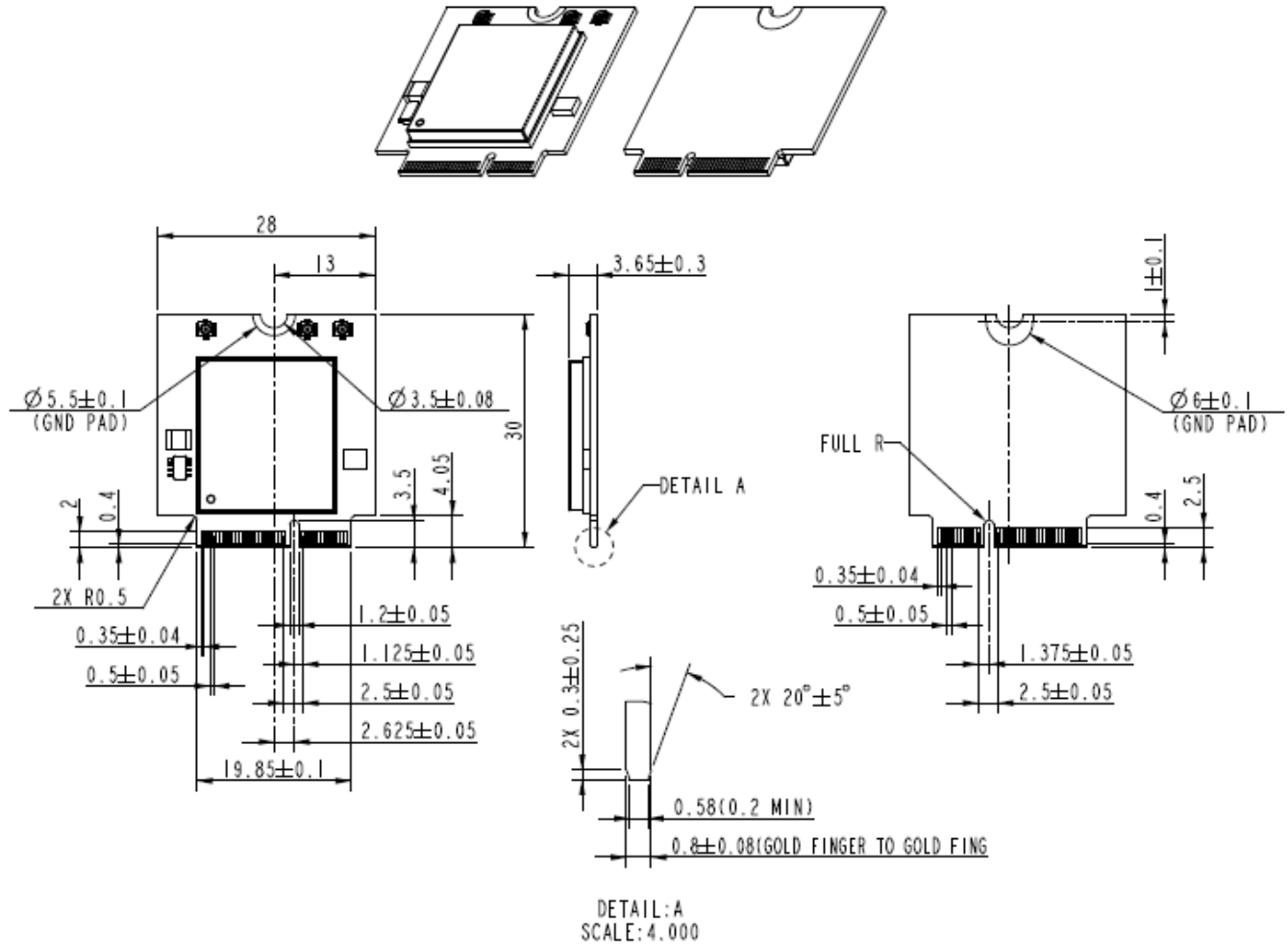

TOLERANCES UNLESS OTHERWISE SPECIFIED: ± 0.15 mm

(Draft drawing)

5. Packing Information

1. 160pcs modules put in the one bottom tray



2. One cover tray put on bottom tray

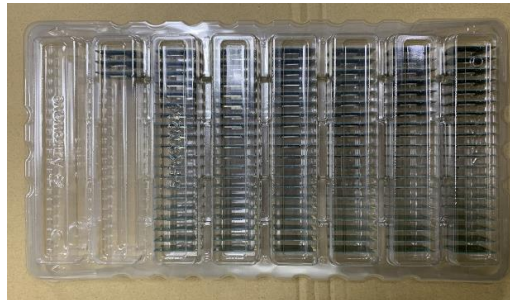

3. **4pcs tray** (cover + bottom) stacked together



4. Use P.P Strap to pack 4 trays

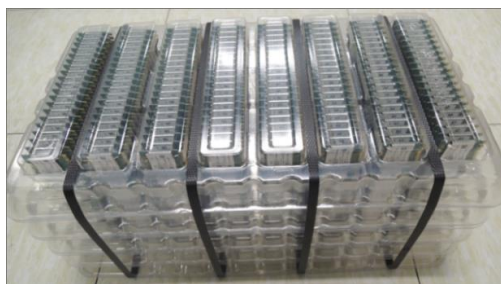

- Put packed trays into inner box
640pcs/box



- Seal the inner box by AzureWave tape



- One package label pasted in side of inner box



8. Two inner boxes put into one carton; 1280pcs/carton
If only one inner box has modules, “Empty” label pasted on the other one inner box





Example:

9. Seal the carton by AzureWave tape



10. One carton label and box label pasted on the carton. If the carton is not full, one balance label pasted on the carton

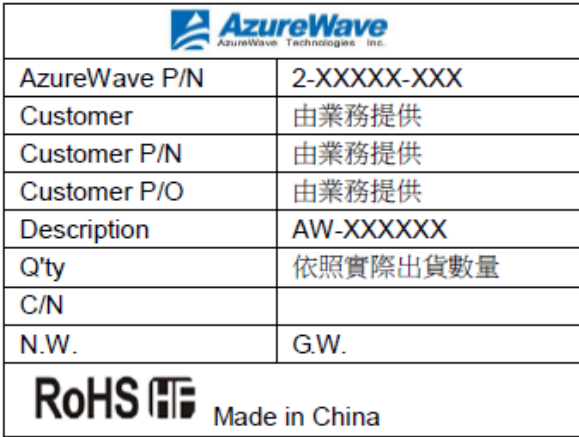

<p>Example of carton label (出貨標籤的範例)</p>	
<p>Example of box label (箱號標籤)</p>	
<p>Example of balance label (尾數標籤)</p>	