

AW-CU479

IEEE802.15.4 Wireless Microcontroller Zigbee 3.0 Stamp LGA Module (M06)

Datasheet

Rev. H

DF

(For STD)

Features

Benefits

- Single chip device to run stack and application
- Very low current solution for long battery life; over 10 years
- Very low RX current for low standby power of mains powered nodes
- Integrated power amplifier for long range and robust communication
- High tolerance to interference from other 2.4 GHz radio sources
- Supports multiple network stacks
- Highly featured 32-bit RISC CPU for high performance and low power
- Large embedded Flash memory to enable over-the-air firmware updates without external Flash memory
- System BOM is low in component count and cost
- Flexible sensor interfacing options

Radio

- Radio link budget 106 dB
- Compensation for temperature drift of crystal oscillator frequency
- 128-bit AES security processor
- MAC accelerator with packet formatting, CRCs, address check, auto-acks, timers
- Integrated ultra low-power RC sleep oscillator (0.7uA)
- 2.0 V to 3.6 V battery operation
- Deep sleep current 50 nA (wake-up from IO)
- Antenna diversity (Auto RX)

Microcontroller

- 32-bit RISC CPU; 1 MHz to 32 MHz clock speed
- Variable instruction width for high coding efficiency
- Multi-stage instruction pipeline
- 512 kB Flash
- 32 kB RAM
- 4 kB EEPROM
- Data EEPROM with guaranteed 100 k write operations
- Zigbee PRO stack with Home Automation, Light Link and Smart Energy profiles
- 2-wire I2C-bus compatible serial interface; can operate as either master or slave
- 5 x PWM (4 timers, 1 timer/counter)
- 2 low-power sleep counters
- 2 x UARTs
- SPI-bus master and slave port, 3 selects
- Supply voltage monitor with 8 programmable thresholds
- 6-input 10-bit ADC, comparator
- Battery and temperature sensors
- Watchdog and Supply Voltage Monitor (SVM)
- Up to 20 Digital IO (DIO) pins

Applications

- Robust and secure low-power wireless applications
- Zigbee 3.0
- Internet of Things (IoT)
- Zigbee Smart Energy networks
- Zigbee Light Link networks
- Zigbee Home Automation networks



- Toys and gaming peripherals
- Energy harvesting

Revision History

Document NO: R2-2479-DST-01

Version	Revision Date	DCN NO.	Description	Initials	Approved
A	2020/4/13	DCN017089	Initial Version	Shihhua Huang	NC Chen
B	2020/5/6	DCN017357	Added more info about chapter 3.2	Shihhua Huang	NC Chen
C	2020/6/16	DCN017621	<ul style="list-style-type: none"> ● Modify pin table ● Modify Storage Temperature 	Shihhua Huang	NC Chen
D	2020/8/11	DCN018074	<ul style="list-style-type: none"> ● Added certification info at chapter 1.3.1 ● Added power consumption 	Shihhua Huang	NC Chen
E	2020/12/24	DCN019674	<ul style="list-style-type: none"> ● Update pin table description 	Shihhua Huang	NC Chen
F	2021/4/14	DCN021286	<p>*Changed to new format</p> <ul style="list-style-type: none"> ● Modify Block Diagram 	Shihhua Huang	NC Chen
G	2021/5/12	DCN021749	<ul style="list-style-type: none"> ● Correct the typo on chapter 1.3.1 certification info 	Shihhua Huang	NC Chen
H	2021/11/24	DCN024241	<ul style="list-style-type: none"> ● Modify chapter 1.3.2 TX power tolerance 	Shihhua Huang	NC Chen

Table of Contents

Revision History.....	4
Table of Contents.....	5
1. Introduction	6
1.1 Product Overview	6
1.2 Block Diagram.....	7
1.3 Specifications Table	8
1.3.1 General	8
1.3.2 Zigbee.....	8
1.3.3 Operating Conditions.....	9
2. Pin Definition	10
2.1 Pin Map.....	10
2.2 Pin Table.....	11
3. Electrical Characteristics	13
3.1 Absolute Maximum Ratings	13
3.2 Recommended Operating Conditions	13
3.3 Digital IO Pin DC Characteristics.....	13
3.4 AC characteristics	14
3.4.1 Reset and Supply Voltage Monitor	14
3.4.2 SPI-bus master timing.....	15
3.4.3 SPI-bus slave timing.....	16
3.5 Power Consumption*	17
4. Mechanical Information	18
4.1 Mechanical Drawing	18
5. Packaging Information	19

1. Introduction

1.1 Product Overview

AzureWave Technologies, Inc. introduces the pioneer of the IEEE 802.15.4 Zigbee module --- AW-CU479. The AW-CU479 wireless microcontroller that provides a fully integrated solution for applications that use the IEEE802.15.4 standard in the 2.4 GHz to 2.5 GHz ISM frequency band, including Zigbee PRO applications based on the Smart Energy, Light Link and Home Automation profiles. The AW-CU479 features 512 kB embedded Flash, 32 kB RAM and 4 kB EEPROM memory. Applications that transfer data wirelessly tend to be more complex than applications for wired solutions. Wireless protocols make stringent demands on frequencies, data formats, and timing of data transfers, security and other issues. Application development must consider the requirements of the wireless network in addition to the product functionality and user interfaces. To minimize this complexity, AzureWave provides a series of software libraries and interfaces that control the transceiver and peripherals of the AW-CU479. These libraries and interfaces remove the need for the developer to understand wireless protocols and greatly simplifies the programming complexities of power modes, interrupts and hardware functionality. In view of the above, we do not provide the AW-CU479 register details in this data sheet. The device includes a wireless transceiver, RISC CPU, on-chip memory and an extensive range of peripherals.

1.2 Block Diagram

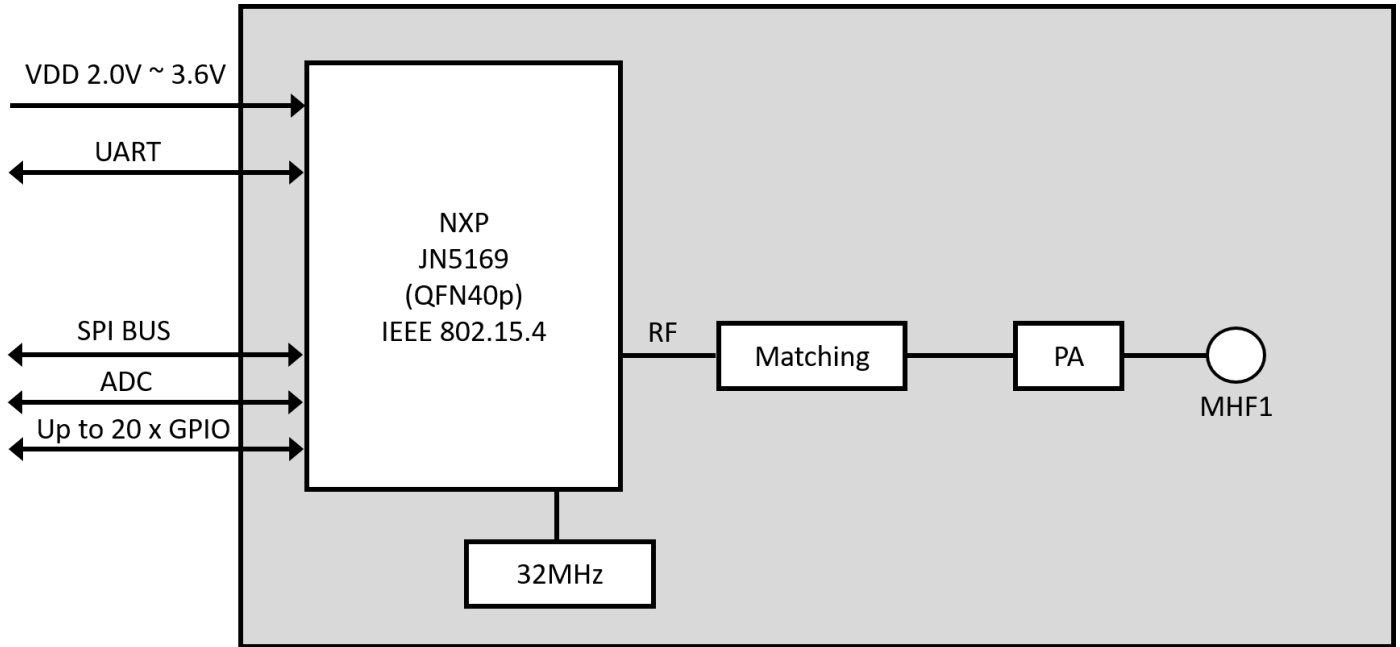

AW-CU479 BLOCK DIAGRAM

1.3 Specifications Table

1.3.1 General

Features	Description						
Product Description	IEEE 802.15.4 Zigbee 3.0 Module (Stamp LGA)						
Major Chipset	JN5169 (QFN 40p)						
Host Interface	Zigbee <ul style="list-style-type: none"> UART 						
Dimension	16mm x 30mm x 2.95mm (Tolerance remarked in mechanical drawing)						
Form factor	Stamp LGA module						
Antenna	I-PEX MHF1 Connector Receptacle (20279) Main : Zigbee → TX/RX						
Certification information	AW-CU479 are FCC, IC and ANATEL certified.						
	<table border="1"> <thead> <tr> <th>FCC ID</th> <th>IC ID</th> <th>ANATEL ID</th> </tr> </thead> <tbody> <tr> <td>XXMJN5169M6V2</td> <td>8764A-JN5169M6</td> <td>04453-16-09529</td> </tr> </tbody> </table>	FCC ID	IC ID	ANATEL ID	XXMJN5169M6V2	8764A-JN5169M6	04453-16-09529
	FCC ID	IC ID	ANATEL ID				
XXMJN5169M6V2	8764A-JN5169M6	04453-16-09529					
Weight	2.1437g						

1.3.2 Zigbee

Features	Description										
WLAN Standard	IEEE 802.15.4 1T1R										
WLAN VID/PID	N/A										
WLAN SVID/SPID	N/A										
Frequency Range	2.4 GHz : 2.405 ~ 2.480 GHz										
Modulation	O-QPSK										
Number of Channels	2.4GHz <ul style="list-style-type: none"> USA, NORTH AMERICA, Canada and Taiwan – 11 ~ 24 China, Australia, Most European Countries – 11 ~ 26 										
Output Power (Board Level Limit)*	2.4G										
	<table border="1"> <thead> <tr> <th></th> <th>Min</th> <th>Typ</th> <th>Max</th> <th>Unit</th> </tr> </thead> <tbody> <tr> <td>15.4 (0.25Mbps) @EVM<35%</td> <td>19</td> <td>22</td> <td>25</td> <td>dBm</td> </tr> </tbody> </table>		Min	Typ	Max	Unit	15.4 (0.25Mbps) @EVM<35%	19	22	25	dBm
		Min	Typ	Max	Unit						
15.4 (0.25Mbps) @EVM<35%	19	22	25	dBm							

Receiver Sensitivity	2.4G				
		Min	Typ	Max	Unit
	15.4 (0.25Mbps)		-97	-94	dBm
Data Rate	Zigbee: 802.15.4: 0.25Mbps				
Security	<ul style="list-style-type: none"> ■ 128-bit AES-CCM modes as specified by the IEEE802.15.4 2006 standard. 				

* If you have any certification questions about output power please contact FAE directly.

1.3.3 Operating Conditions

Features	Description
Operating Conditions	
Voltage	Power supply for host: 2.0V ~ 3.6V
Operating Temperature	-40°C ~ 85°C
Operating Humidity	less than 85%R.H.
Storage Temperature	-40°C ~ 125°C
Storage Humidity	less than 60%R.H.
ESD Protection	
Human Body Model	2KV
Changed Device Model	1000V

2. Pin Definition

2.1 Pin Map

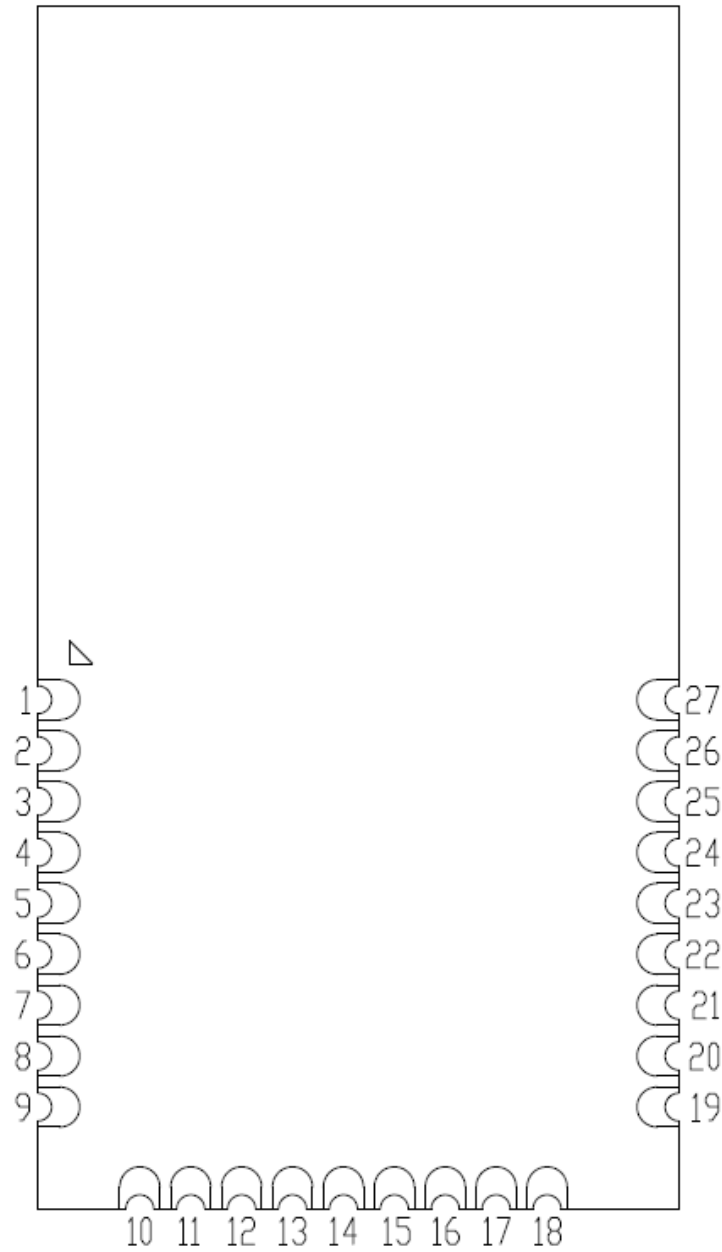

AW-CU479 Pin Map (Top View)

2.2 Pin Table

Pin No	Definition	Basic Description	Voltage	Type
1	ADC1	ADC input		I
2	SPICLK	SPI-bus master clock output		O
3	SPIMISO	SPI-bus Master In, Slave Out input		I/O
4	SPIMOSI	SPI-bus Master Out Slave In output		I/O
5	SSZ	SPI-bus master Select Output 0		I/O
6	DIO0	DIO0		I/O
7	DIO1	DIO1		I/O
8	DIO2	DIO2		I/O
9	DIO3	DIO3		I/O
10	DIO4	DIO4 UART 0 clear to send input		I/O
11	DIO5	DIO5 UART 0 request to send output		I/O
12	DIO6	DIO6 UART 0 transmit data output		I/O
13	DIO7	DIO7 UART 0 receive data input		I/O
14	DIO8	DIO8		I/O
15	DIO9	DIO9		I/O
16	DIO10	DIO10		I/O
17	VDD	Supply voltage		P
18	GND	Ground.		GND
19	DIO11	DIO11		I/O

20	DIO12	DIO12		I/O
21	DIO13	DIO13		I/O
22	RESETN	Reset input		I
23	DIO14	DIO14		I/O
24	DIO15	DIO15		I/O
25	DIO16	DIO16		I/O
26	DIO17	DIO17		I/O
27	ADC2	ADC2 input		I

3. Electrical Characteristics

3.1 Absolute Maximum Ratings

Symbol	Parameter	Conditions	Minimum	Maximum	Unit
V _{DD}	Power supply voltage		-0.3	3.6	V
V _{ADC1}	Voltage on pin ADC1		-0.3	V _{DD} +0.3	V
V _{IO(dig)}	Digital input/output voltage		-0.3	V _{DD} +0.3	V

3.2 Recommended Operating Conditions

Symbol	Parameter	Minimum	Typical	Maximum	Unit
V _{DD} ^[1]	Power supply voltage	2	--	3.6	V

[1] To reach the maximum TX power, 2.8 V is the minimum and 3.3V is maximum.

3.3 Digital IO Pin DC Characteristics

Table 1. Digital IO DC Characteristics

Symbol	Parameter	Minimum	Typical	Maximum	Unit
V _{IH}	Input high voltage	0.7*V _{DD}	--	V _{DD}	V
V _{IL}	Input low voltage	-0.3	--	0.27*V _{DD}	V
V _{hys(i)}	Input hysteresis voltage				

Table 2. Output on pins DIOx^[1]

Symbol	Parameter	Minimum	Typical	Maximum	Unit
V _{OH}	Output high voltage	V _{DD} -0.4	--	V _{DD}	V
V _{OL}	Output low voltage	0	--	0.4	V

[1] With x = 0, 1, 2, 3, 4, 5, 6, 7, 8, 9, 10, 11, 12, 13, 14, 15, 16, 17, 18 or 19.

3.4 AC characteristics

3.4.1 Reset and Supply Voltage Monitor

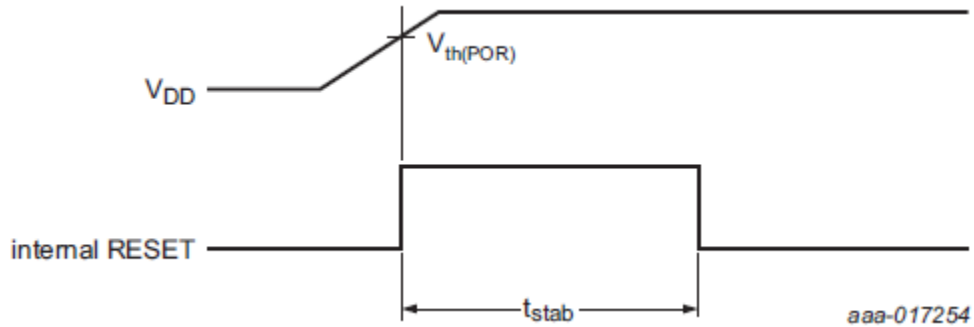

Fig 1. Internal Power-On Reset without showing Brown-Out

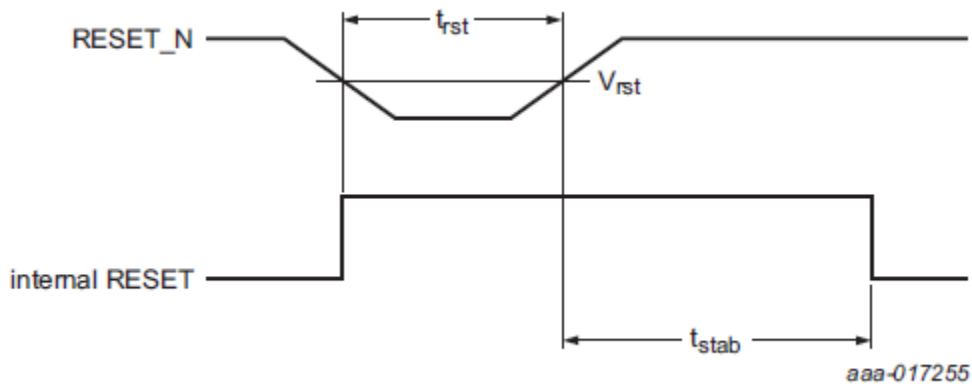
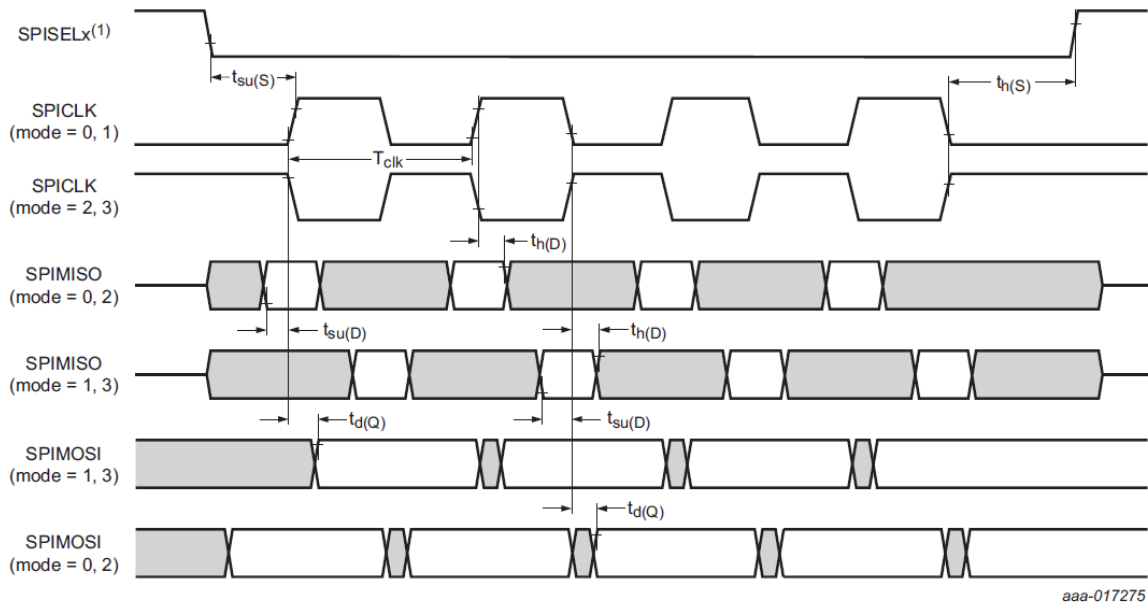

Fig 2. Externally applied reset

Table 3. Externally applied reset

Symbol	Parameter	Conditions	Min	Typical	Max	Unit
t_{rst}	Reset time	External reset pulse width to initiate reset sequence	1			us
V_{rst}	Reset voltage	External threshold voltage	$0.7 \cdot V_{DD}$			V
$V_{th(POR)}$	Power-on threshold voltage	Rise time >10ms				
		Rising	-	1.44		V
		Falling	-	1.41		V
α spike	Spike rejection	Depth of pulse to trigger reset				
		1us square wave		1.2		V
		10us triangular wave		1.3		V
T_{stab}	Stabilization time	Reset		180		us

3.4.2 SPI-bus master timing



(1) With x = 0, 1 or 2.

Table 4. SPI-bus master timing

Symbol	Parameter	Conditions	Min	Typical	Max	Unit
T_{clk}	Clock period		62.5			ns
$T_{su(D)}$	Data input set-up time	3.3V	12.5			ns
		2.7V	13			
		2.0V	14			
$T_{h(D)}$	Data input hold time		0			ns
$T_{d(Q)}$	Data output delay time	On SPIMOSI			15	ns
$T_{su(S)}$	Chip select set-up time		60			ns
$T_{h(S)}$	Chip select hold time	SPICLK = 16MHz	30			ns
		SPICLK < 16MHz; mode =0 or 2	0			
		SPICLK < 16MHz; mode =1 or 3	60			

3.4.3 SPI-bus slave timing

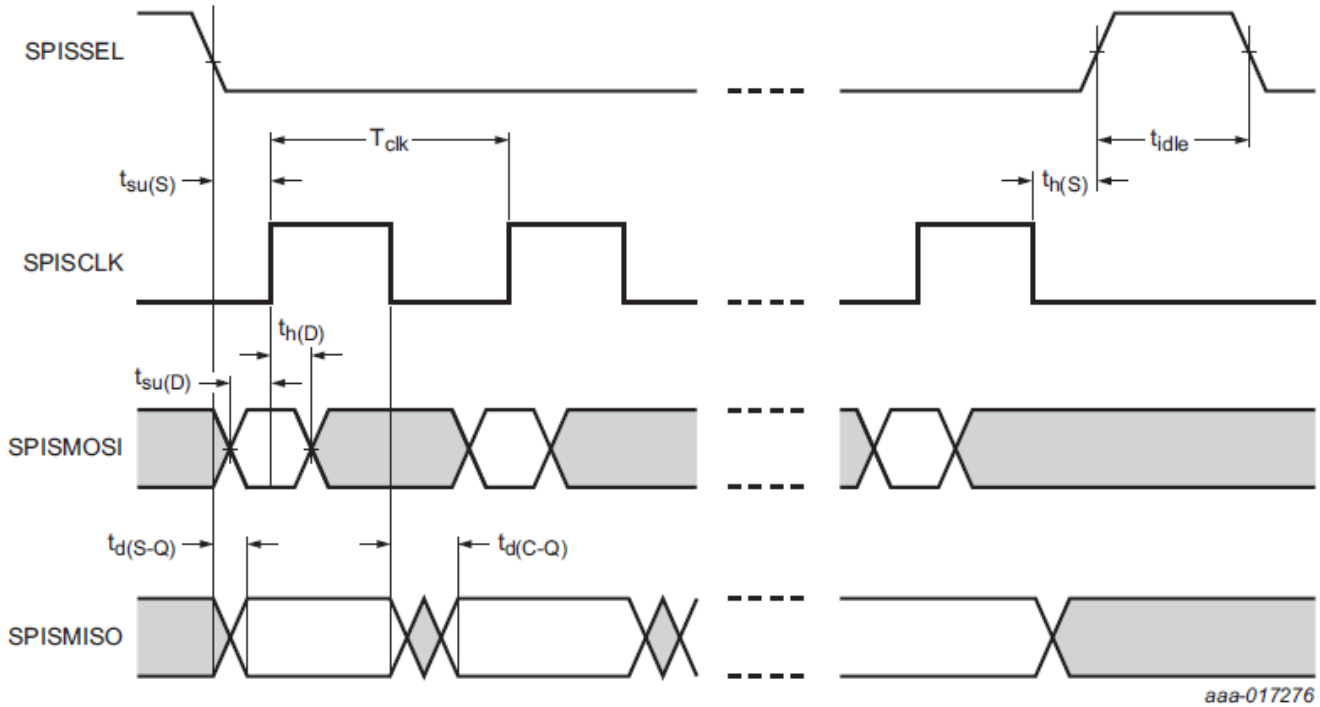

aaa-017276

Table 5. PERST# Timing Parameters

Symbol	Parameter	Conditions	Min	Typical	Max	Unit
T_{clk}	Clock period		125	-	-	ns
t_{idle}	Idle time		125	-	-	ns
$t_{su(D)}$	Data input set-up time		10	-	-	ns
$t_{th(D)}$	Data input hold time		10	-	-	ns
$t_{d(C-Q)}$	Clock to data output delay time	SPISCLK falling edge to SPISMISO output delay time	-	-	30	ns
$t_{d(S-Q)}$	Chip select to data output delay time	SPISSEL falling edge to SPISMISO output delay time	-	-	30	ns
$t_{su(S)}$	Chip select set-up time	SPISSEL falling edge to SPISCLK rising edge delay time	30	-	-	ns
$t_{th(S)}$	Chip select hold time	SPISCLK falling edge to SPISSEL rising edge delay time	30	-	-	ns

3.5 Power Consumption*

No.	Item	VDD_IN=3.3 V	
		Max.	Avg.
1	Deep sleep mode	1.7 uA	0.207 uA
2	Sleep mode without memory retention (60seconds)	2.09 uA	0.819 uA
3	Transmit mode (23.8dBm)	241 mA	240 mA
4	Receive mode, maximum input level at 0 dBm	22 mA	21.9 mA

4. Mechanical Information

4.1 Mechanical Drawing

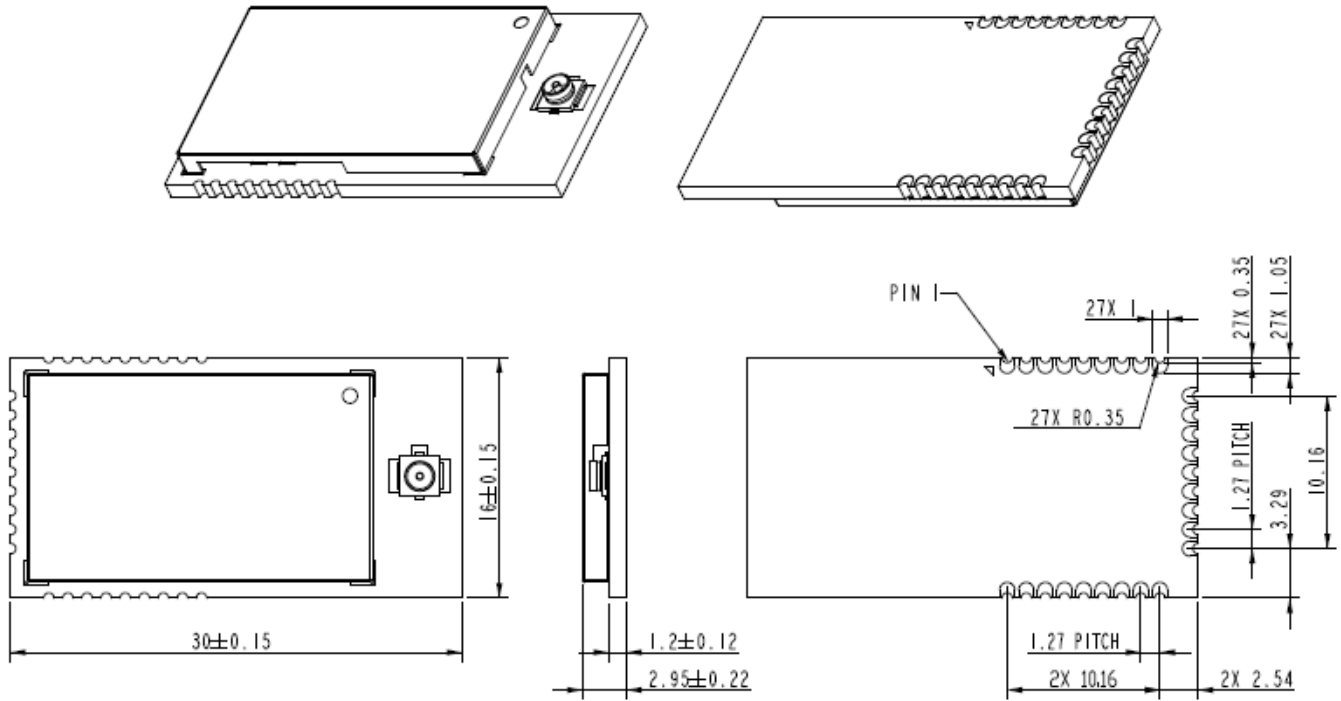

5. Packaging Information

1. One reel can pack 600pcs 16x30 stamp LGA modules
2. One production label is pasted on the reel, one desiccant and one humidity indicator card are put on the reel

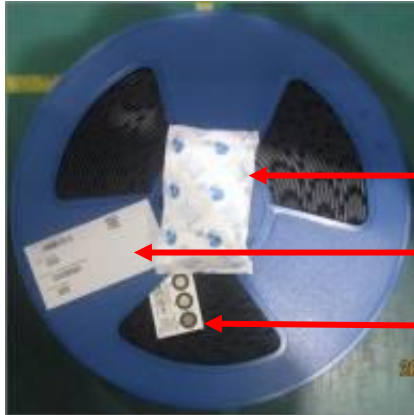

One desiccant

One production label

One humidity indicator card

3. One reel is put into the anti-static moisture barrier bag, and then one label is pasted on the bag



One production label

4. A bag is put into the anti-static pink bubble wrap

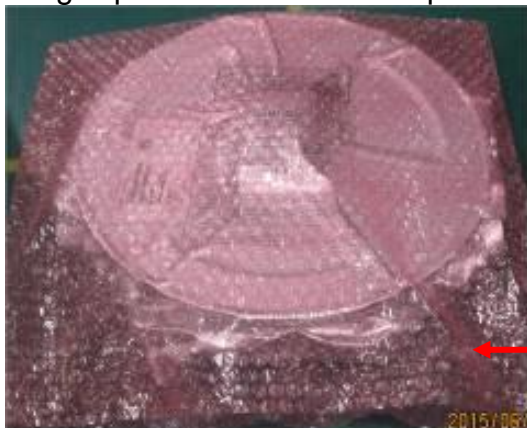

One anti-static pink bubble wrap

5. A bubble wrap is put into the inner box and then one label is pasted on the inner box



One production label

6. **3 inner boxes** could be put into one carton



7. Sealing the carton by AzureWave tape















8. One carton label and one box label are pasted on the carton. If one carton is not full, one balance label pasted on the carton

One carton label
出貨標籤

One production label
生產標籤

One box label
箱號標籤



<p>Example of carton label (出貨標籤的範例)</p>	 <table border="1" data-bbox="764 667 1279 1220"> <tr> <td colspan="2" style="text-align: center;"> AzureWave Technologies Inc.</td> </tr> <tr> <td>AzureWave P/N</td> <td></td> </tr> <tr> <td>Customer</td> <td>由業務提供</td> </tr> <tr> <td>Customer P/N</td> <td>由業務提供</td> </tr> <tr> <td>Customer PO</td> <td>由業務提供</td> </tr> <tr> <td>Description</td> <td>AW-XXXXXX</td> </tr> <tr> <td>QTY</td> <td>1200 pcs</td> </tr> <tr> <td>C/N</td> <td></td> </tr> <tr> <td>N.W.</td> <td>G.W.</td> </tr> <tr> <td colspan="2" style="text-align: center;"></td> </tr> </table>	 AzureWave Technologies Inc.		AzureWave P/N		Customer	由業務提供	Customer P/N	由業務提供	Customer PO	由業務提供	Description	AW-XXXXXX	QTY	1200 pcs	C/N		N.W.	G.W.		
 AzureWave Technologies Inc.																					
AzureWave P/N																					
Customer	由業務提供																				
Customer P/N	由業務提供																				
Customer PO	由業務提供																				
Description	AW-XXXXXX																				
QTY	1200 pcs																				
C/N																					
N.W.	G.W.																				
																					
<p>Example of box label (箱號標籤)</p>																					
<p>Example of production label (生產標籤)</p>	 <p>P/N: </p> <p>D/C: 1309 </p> <p>PCK NO.: PCKNO0069097 </p> <p>QTY: 294 </p> <p>BAG SEAL DATE: _____</p>																				



<p>Example of balance label (尾數標籤)</p>	
--	--